

Dual LDO

Monolithic IC MM3548 Series

Outline

MM3548 are dual LDO by small package. The IC are used for a smart phone's and mobile phone's RF or CMOS sensor power supply by high PSRR and load response.

150mA *2ch, PLP-6 (1212size)

Features

1. Maximum input voltage	7V
2. Maximum operating voltage	6V
3. No load input current	40μA typ. (1ch)
4. Quiescent current (OFF)	0.1μA typ. (Vce=0V)
5. Output voltage range	1.2 to 5.0V (0.1V step)
6. Output voltage accuracy	±1.0%/±20mV (Vo≤2V)
7. Dropout voltage	0.21V typ. (Io=150mA, Vo=3V)
8. Line regulation	0.1%/V max.
9. Load regulation	40mV max. (Io=1 to 150mA)
10. Vout temperature coefficient	±80ppm/°C typ.
11. Output NMOS ON resistance	10Ω typ.
12. Output Capacitor	1.0μF

Package

PLP-6C

Applications

1. Smart phone
2. Mobile phone
3. DSC

Block Diagram

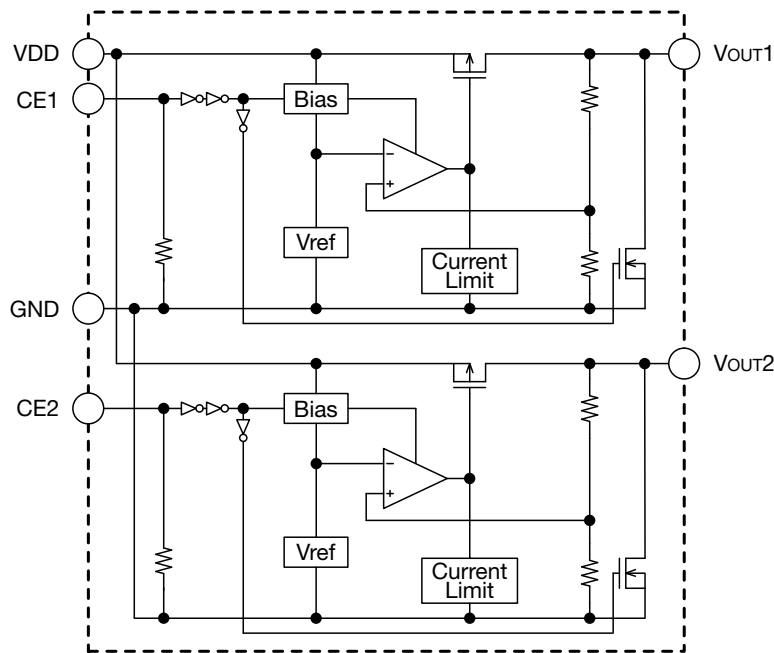

Pin Assignment

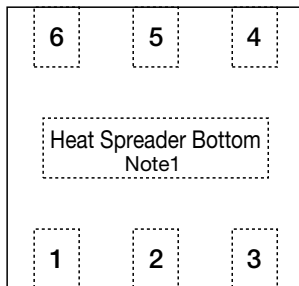

PLP-6C
(TOP VIEW)

1	Vout1
2	Vout2
3	GND
4	CE2
5	VDD
6	CE1

Note1 : Heat Spreader Bottom with GND.

Pin Description

Pin No.	Pin name	Functions						
1	Vout1	Output pin						
2	Vout2	Output pin						
3	GND	GND pin						
4, 6	CE2, CE1	ON/OFF-Control pin <table border="1" style="margin-left: 20px;"> <tr> <th>CE</th> <th>OUTPUT</th> </tr> <tr> <td>L</td> <td>OFF</td> </tr> <tr> <td>H</td> <td>ON</td> </tr> </table> Connect CE pin with VDD pin, when it is not used.	CE	OUTPUT	L	OFF	H	ON
CE	OUTPUT							
L	OFF							
H	ON							
5	VDD	Voltage-Supply pin						

• Any products mentioned in this catalog are subject to any modification in their appearance and others for improvements without prior notification.
 • The details listed here are not a guarantee of the individual products at the time of ordering. When using the products, you will be asked to check their specifications.

Absolute Maximum Ratings (Except where noted otherwise Ta=25°C)

Item	Symbol	Ratings	Units
Storage Temperature	T _{stg}	-55~150	°C
Junction Temperature	T _{JMAX}	150	°C
Supply Voltage	V _{DD}	-0.3~7.0	V
CE1, 2 input Voltage	V _{CE}	-0.3~7.0	V
Output Voltage 1, 2	V _{OUT1, 2}	-0.3~7.0	V
Output Current 1	I _{OMAX1}	200	mA
Output Current 2	I _{OMAX2}	200	mA
Power Dissipation (Note1)	P _d	970	mW

Note1 : JEDEC51-7 standard 114.3mm × 76.2mm t=1.6mm

Recommended Operating Conditions (Except where noted otherwise Ta=25°C)

Item	Symbol	Ratings	Units
Operating Ambient Temperature	T _{opr}	-40~85	°C
Operating Junction Temperature (Note2)	T _{jop}	125	°C
Operating Voltage	V _{op}	1.6~6.0	V
Output Current 1, 2	I _{op}	0~150	mA

Note2 : In consideration of product life, the use in less than 80% of T_{jop}(max.) is recommended.

Electrical Characteristics 1 (Except where noted otherwise $V_{DD}=V_{OUT}(TYP.)+1V$, $V_{CE}=V_{DD}$, $T_a=25^{\circ}C$)

Item	Symbol	Measurement conditions	Min.	Typ.	Max.	Units
Input Current (OFF)	I_{DDOFF}	$V_{CE}=0V$ It is a value for each 1ch.		0.1	1.0	μA
No-Load Input Current	I_{DD}	$I_{OUT}=0mA$ It is a value for each 1ch.		40	70	μA
Output Voltage 1	V_{OUT1}	$I_{OUT}=1mA, V_{OUT} \geq 2.0V$	$\times 0.99$		$\times 1.01$	V
		$I_{OUT}=1mA, V_{OUT} \leq 2.0V$	-0.020		0.020	
Output Voltage 2 (Note3)	V_{OUT2}	$I_{OUT}=1mA, V_{OUT} \geq 2.0V$ $-40 \leq T_{opr} \leq 85^{\circ}C$	$\times 0.97$		$\times 1.03$	V
		$I_{OUT}=1mA, V_{OUT} \leq 2.0V$ $-40 \leq T_{opr} \leq 85^{\circ}C$	-0.060		0.060	
Line Regulation	V_{LINE}	$V_{OUT}(typ.)+0.5V \leq V_{DD} \leq 6.0V$ $I_{OUT}=1mA, V_{OUT} > 1.5V$		0.02	0.10	% / V
		$2.0V \leq V_{DD} \leq 6.0V$ $I_{OUT}=1mA, V_{OUT} \leq 1.5V$				
Load Regulation	V_{LOAD}	$1mA \leq I_{OUT} \leq 150mA$		10	40	mV
Dropout Voltage	V_{io}	Please refer to another page				V
Output Short-Circuit Current (Note3)	I_{short}	$V_{OUT}=0V$		40		mV
V_{OUT} Temperature Coefficient (Note3)	$\Delta V_{out} / \Delta T_{op}$	$I_{OUT}=1mA$ $-40 \leq T_{opr} \leq 85^{\circ}C$		± 80		ppm / $^{\circ}C$
Ripple Rejection (Note3)	RR	$f=1kHz, V_{ripple}=0.5V, I_{OUT}=30mA$		70		dB
CE High Threshold Voltage	V_{CEH}		1.0		6.0	V
CE Low Threshold Voltage	V_{CEL}				0.4	mA
CE Pin Current (Note3)	I_{CE}			0.3		μA
Output Noise Voltage (Note3)	V_n	$Bw=10Hz$ to $100kHz$ $I_{OUT}=1mA$		100		μV_{rms}
Output NMOS ON Resistance (Note3)	R_{DON}			10		Ω

Note3 : The parameter is guaranteed by design.

Electrical Characteristics 2 (Except where noted otherwise $V_{DD}=V_{OUT}(TYP.)+1V$, $V_{CE}=V_{DD}$, $T_a=25^{\circ}C$)

Output Voltage V_{OUT} (V)	Item							
	Output Voltage				Dropout Voltage			
	V_{OUT} (V)				V_{io} (V)			
	Measurement Conditions	Min.	Typ.	Max.	Measurement Conditions	Min.	Typ.	Max.
1.20	$I_{OUT}=1mA$	1.180	1.200	1.220	$I_{OUT}=150mA,$ $1.2V \leq V_{OUT} \leq 2.0V$ (Note4)		0.42	0.62
1.30		1.280	1.300	1.320				
1.40		1.380	1.400	1.420				
1.50		1.480	1.500	1.520			0.37	0.55
1.60		1.580	1.600	1.620				
1.70		1.680	1.700	1.720				
1.80		1.780	1.800	1.820			0.31	0.48
1.90		1.880	1.900	1.920				
2.00		1.980	2.000	2.020				
2.10		2.079	2.100	2.121				
2.20		2.178	2.200	2.222		0.30	0.46	
2.30		2.277	2.300	2.323				
2.40		2.376	2.400	2.424				
2.50		2.475	2.500	2.525				
2.60		2.574	2.600	2.626				
2.70		2.673	2.700	2.727		0.27	0.39	
2.80		2.772	2.800	2.828				
2.85		2.822	2.850	2.879				
2.90		2.871	2.900	2.929				
3.00		2.970	3.000	3.030	$I_{OUT}=150mA,$ $2.0V < V_{OUT} \leq 5.0V$ $V_{DD}=V_{OUT}(TYP.)-0.2V$			
3.10	3.069	3.100	3.131					
3.20	3.168	3.200	3.232					
3.30	3.267	3.300	3.333					
3.40	3.366	3.400	3.434					
3.50	3.465	3.500	3.535					
3.60	3.564	3.600	3.636					
3.70	3.663	3.700	3.737					
3.80	3.762	3.800	3.838					
3.90	3.861	3.900	3.939					
4.00	3.960	4.000	4.040			0.21	0.32	
4.10	4.059	4.100	4.141					
4.20	4.158	4.200	4.242					
4.30	4.257	4.300	4.343					
4.40	4.356	4.400	4.444					
4.50	4.455	4.500	4.545					
4.60	4.554	4.600	4.646					
4.70	4.653	4.700	4.747					
4.80	4.752	4.800	4.848					
4.90	4.851	4.900	4.949					
5.00	4.950	5.000	5.050					

Note4 : Dropout voltage maximum value in the input and it is confirmed that there is no output abnormal voltage impression the 150mA in the model less than $V_{OUT} \leq 2.0V$.

• Any products mentioned in this catalog are subject to any modification in their appearance and others for improvements without prior notification.
 • The details listed here are not a guarantee of the individual products at the time of ordering. When using the products, you will be asked to check their specifications.

Measuring Circuit

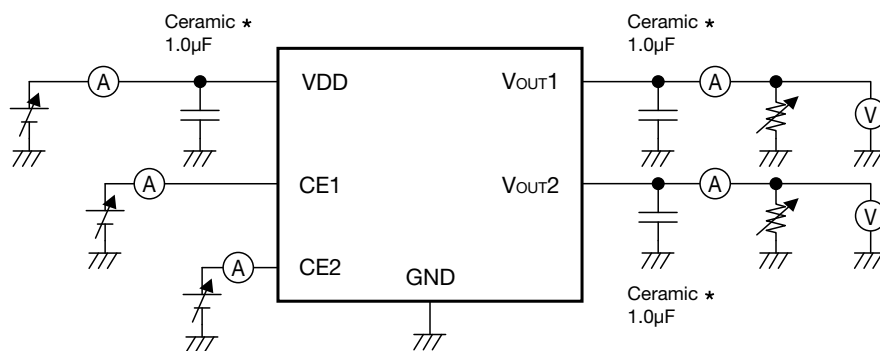

Application Circuit

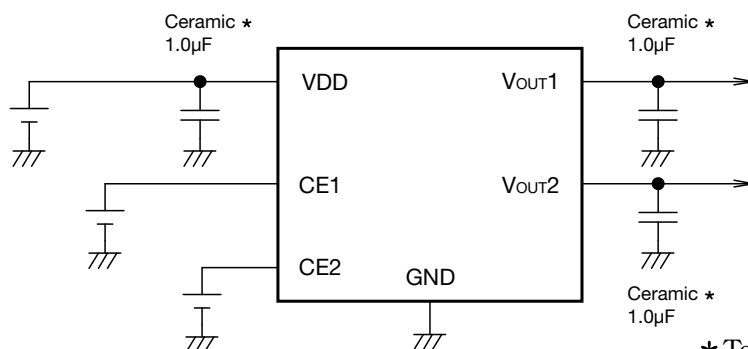

* Temperature Characteristics : B

(Reference example of external parts)

- Output capacitor Ceramic capacitor 1.0µF
- Input capacitor Ceramic capacitor 1.0µF

- In the event a problem which may affect industrial property or any other rights of us or a third party is encountered during the use of information described in these circuit, we shall not be liable for any such problem, nor grant a license therefore.

· Note

1. There is a possibility with deterioration and destruction of IC when using it exceeding the absolute maximum rating.
The absolute maximum rating, Never exceed it.
The functional operation is not assured.
2. There is a possibility that it becomes impossible to maintain this performance and reliability IC original when using it exceeding recommended operation voltage.
Please use it in recommended operation voltage.
3. Due to restrictions on the package power dissipation, the output current value may not be satisfied.
Attention should be paid to the power dissipation of the package when the output current is large or the voltage between Input and Output is high.
4. The output capacitor is required between output and GND to prevent oscillation.
5. The ESR of capacitor must be defined in ESR stability area.
It is possible to use a ceramic capacitor without ESR resistance for output.
The ceramic capacitor must be used more than 1.0 μ F and B temperature characteristics.
6. The wire of VDD and GND is required to print full ground plane for noise and stability.
7. The input capacitor must be connected a distance of less than 1cm from input pin.
8. In case the output voltage is above the input voltage, the overcurrent flow by internal parasitic diode from output to input. In such application, the external bypass diode must be connected between output and input pin.

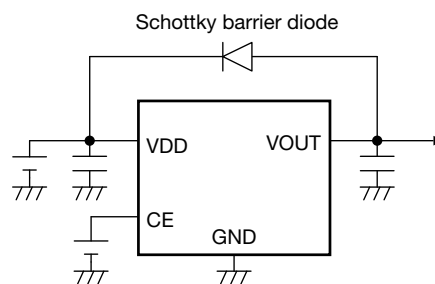

9. It is able to an unstable operation when you use the capacitor with intense capacitance change
The capacitor has the dependency at the power-supply voltage and the temperature.
The capacity value changes by the environment used. Please evaluate IC in the set.
10. The overcurrent protection circuit of foldback current limit type is built into this IC.
11. This IC have not the thermal shutdown protection.
12. This IC will limit the output current with the overcurrent protection circuit when the overcurrent and the output do short-circuit.
However, IC generates heat because of the substrate and use conditions and there is a possibility of destroying it exceeding a permissible loss.
The characteristic changes depending on the substrate condition.
Please evaluate IC in the set.
13. This IC has the pull-down function of the CE terminal.
The pull-down function uses the internal constant current source.
14. The short circuit electric current has dependence of the input voltage.
Short circuit electric currents more than 100mA may flow ($VDD \leq 2V$).
15. Transient response characteristics may turn worse, when dropout voltage is less than 0.5V.
When a dropout voltage does not have a margin, please evaluate it enough.

About Power Dissipation

The Power dissipation change if board to mount IC change because radiative heat fix at board. It is reference data below, Evaluate IC in the set.

1. JEDEC51-7 standard

Board size 114.3mm×76.2mm t=1.6mm Copper foil area 80%
 Power dissipation 1250mW Ta=25°C (It is reference value measured by JEDEC51-7 standard.)

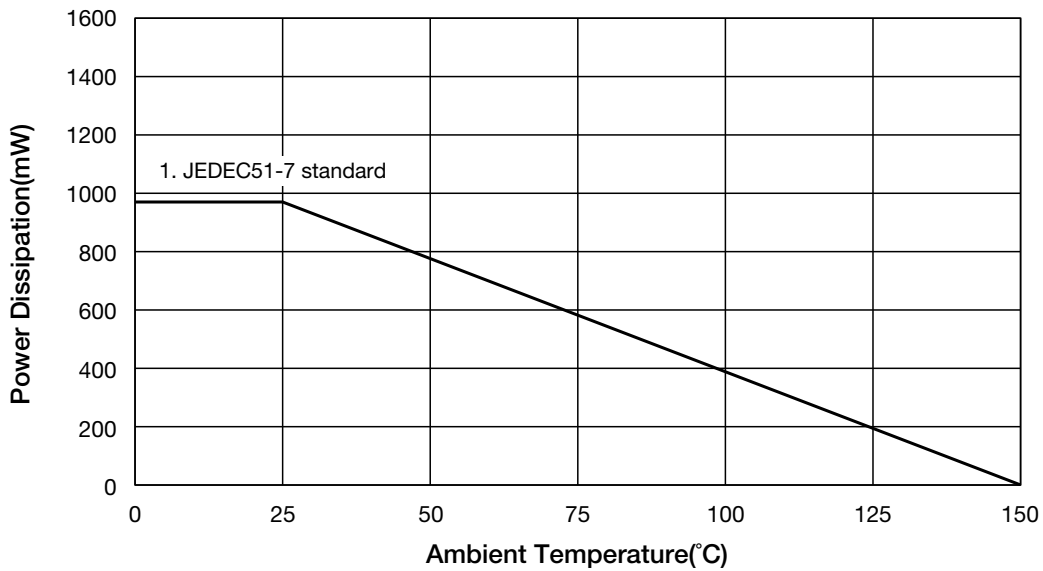

It is recommended to layout the VIA for heat radiation in the GND pattern of reverse (of IC) when there is the GND pattern in the inner layer (in using multilayer substrate).

By increasing these copper foil pattern area of PCB, Power dissipation improves.

Characteristics ($V_{OUT}=1.2V$) (Except where noted otherwise $V_{DD}=V_{OUT}(TYP.)+1V$, $V_{CE}=V_{DD}$, $T_a=25^{\circ}C$)

Input Voltage - Output Voltage

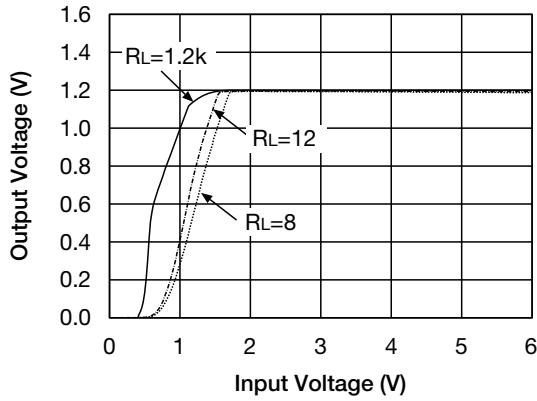

Input Voltage - Input Current

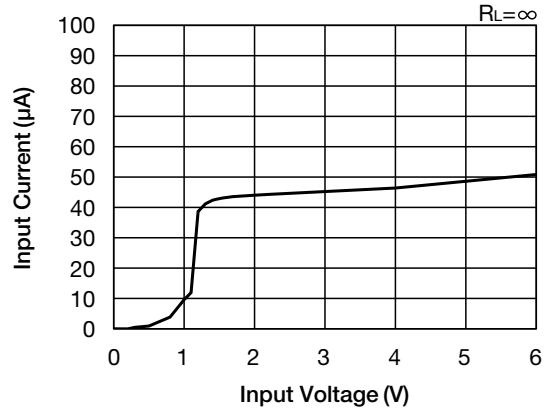

Load Regulation

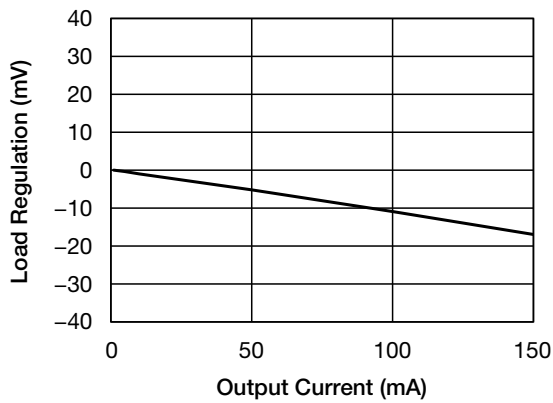

Line Regulation

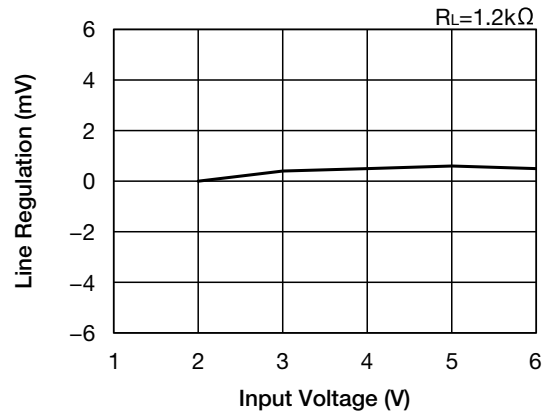

Ripple Rejection

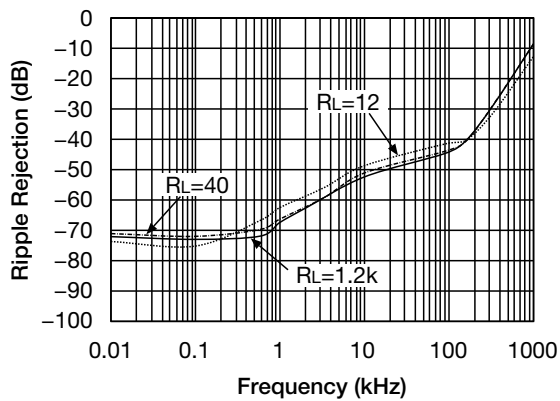

• Any products mentioned in this catalog are subject to any modification in their appearance and others for improvements without prior notification.
 • The details listed here are not a guarantee of the individual products at the time of ordering. When using the products, you will be asked to check their specifications.

■ Output Current - Output Voltage

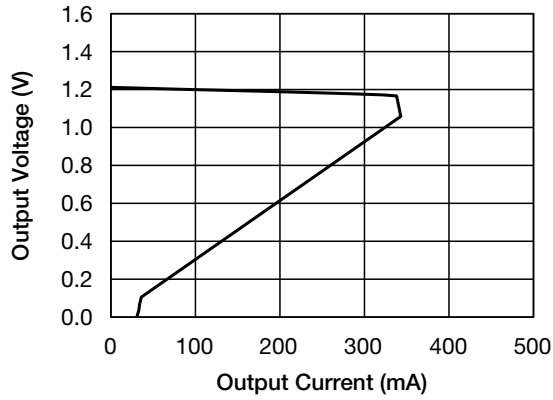

■ ESR stable area

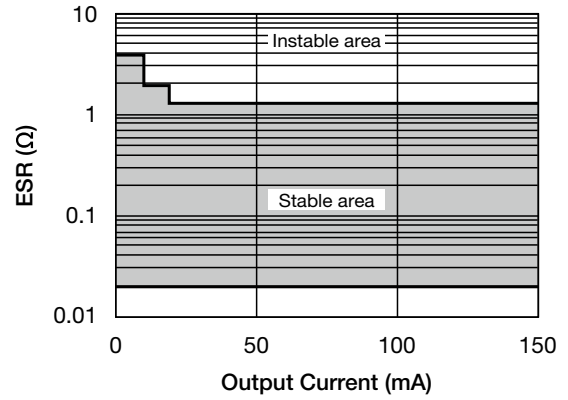

■ Output Voltage - Temperature Coefficient

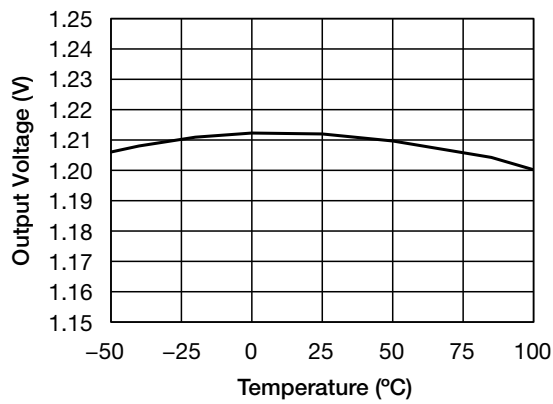

■ Output Noise Voltage

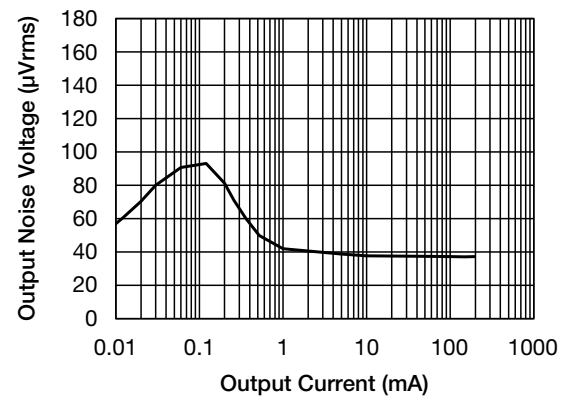

■ Load Transient response
(VDD=2.2V)

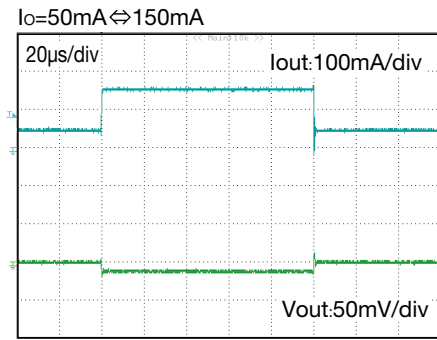

(VDD=1.7V)

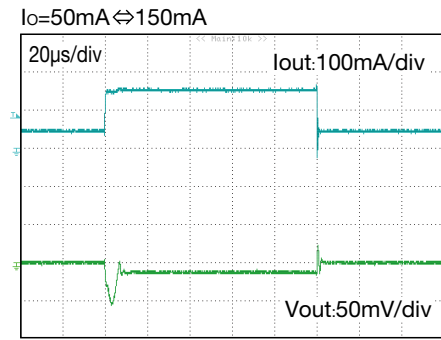

■ CE rise characteristics
(VDD=2.2V)

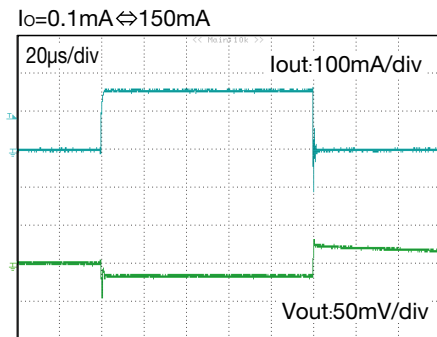

■ Vout discharge characteristics
(VDD=1.7V)

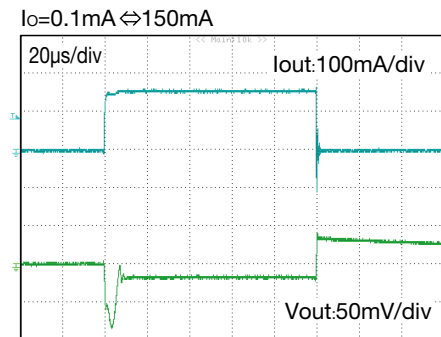

■ CE rise characteristics
(VDD=2.2V, CE=0V→VDD)

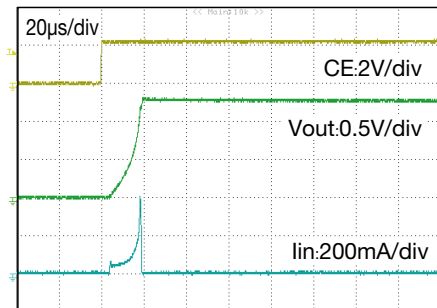

■ Vout discharge characteristics
(VDD=2.2V, CE=VDD→0V)

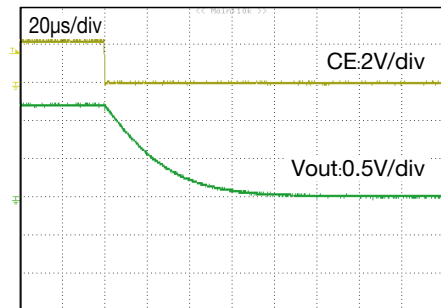

Characteristics (V_{OUT}=3.3V) (Except where noted otherwise V_{DD}=V_{OUT}(TYP.)+1V, V_{CE}=V_{DD}, T_a=25°C)

Input Voltage - Output Voltage

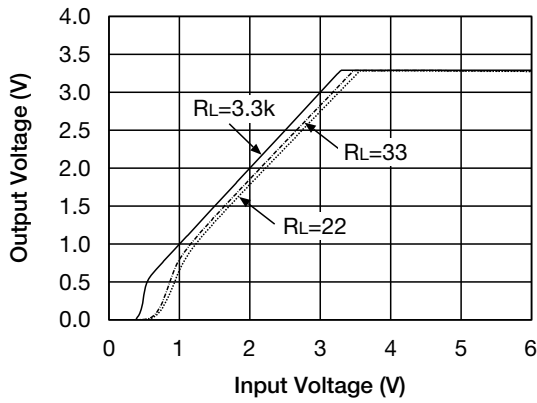

Input Voltage - Input Current

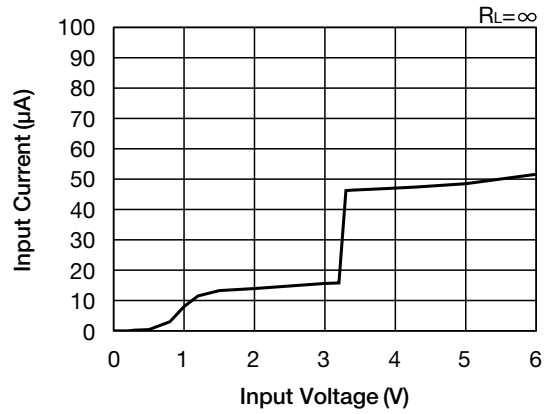

Load Regulation

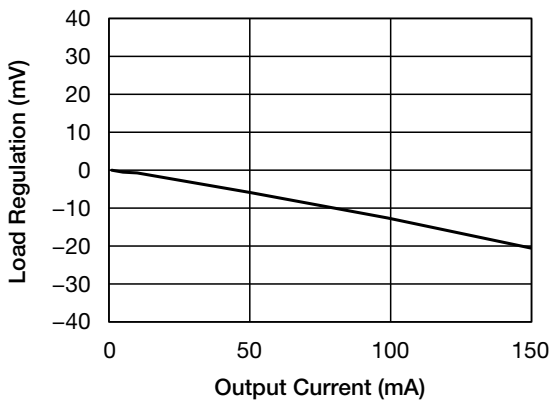

Line Regulation

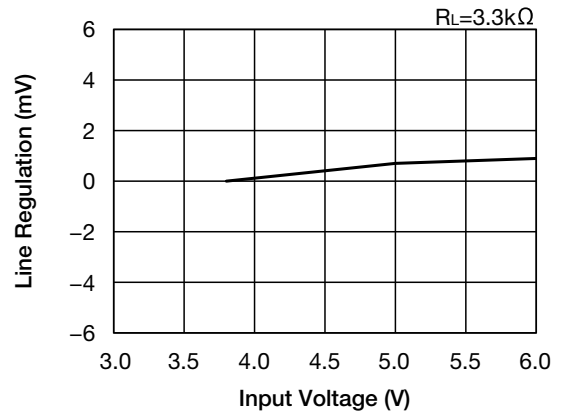

Dropout Voltage

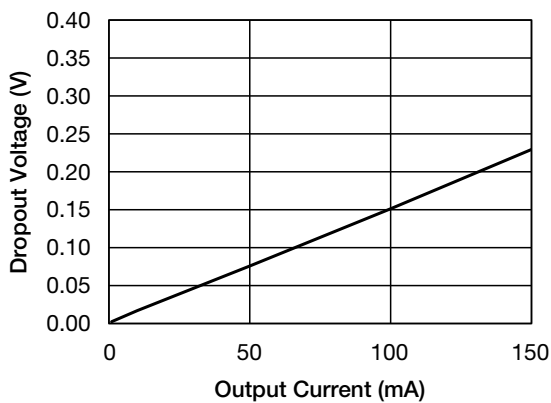

Ripple Rejection

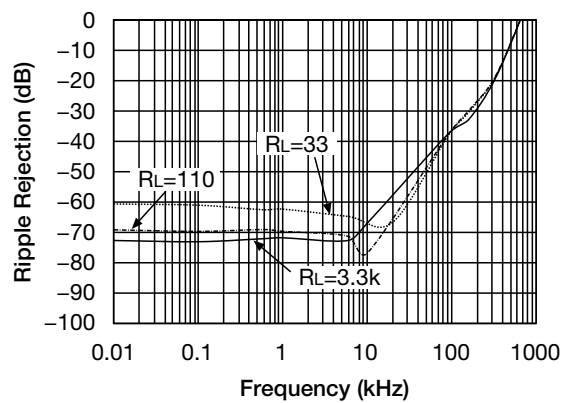

• Any products mentioned in this catalog are subject to any modification in their appearance and others for improvements without prior notification.
 • The details listed here are not a guarantee of the individual products at the time of ordering. When using the products, you will be asked to check their specifications.

■ Output Current - Output Voltage

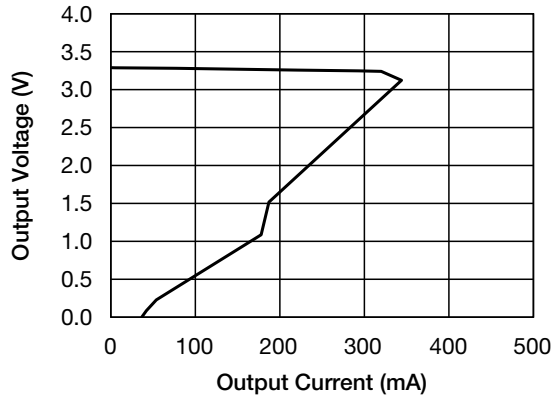

■ ESR stable area

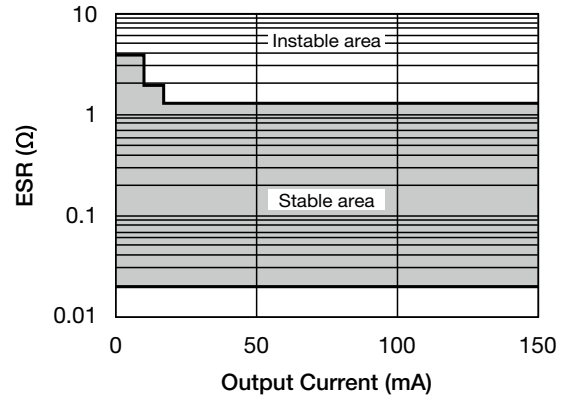

■ Output Voltage - Temperature Coefficient

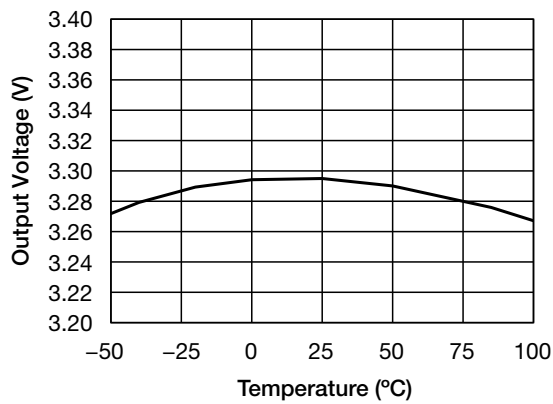

■ Output Noise Voltage

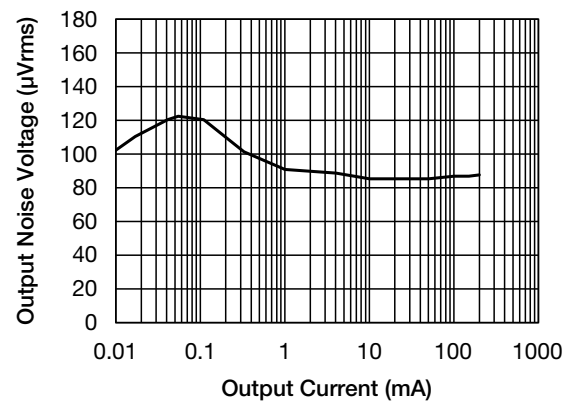

Load Transient response (VDD=4.3V)

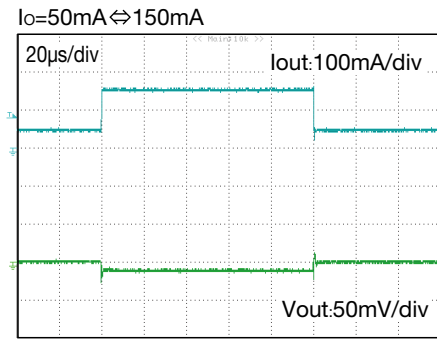

(VDD=3.8V)

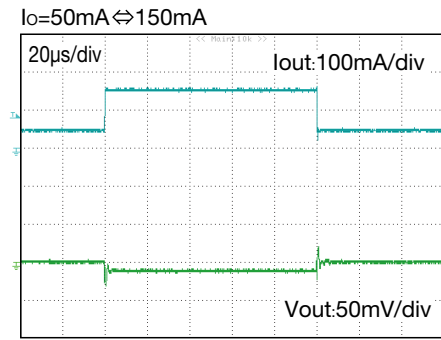

CE rise characteristics (VDD=4.3V)

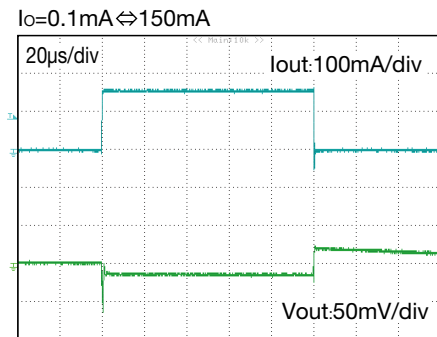

Vout discharge characteristics (VDD=3.8V)

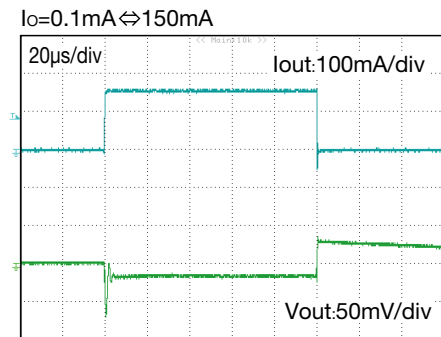

CE rise characteristics (VDD=3.8V, CE=0V→VDD)

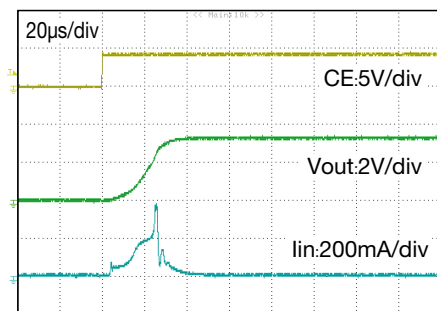

Vout discharge characteristics (VDD=3.8V, CE=VDD→0V)

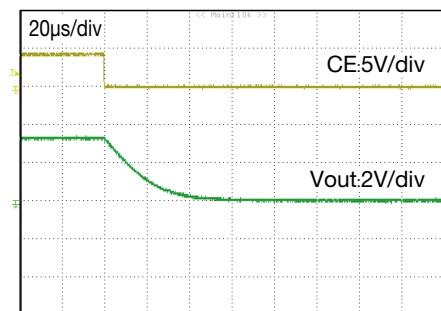

Characteristics (V_{OUT}=5.0V) (Except where noted otherwise V_{DD}=V_{OUT}(TYP.)+1V, V_{CE}=V_{DD}, T_a=25°C)

Input Voltage - Output Voltage

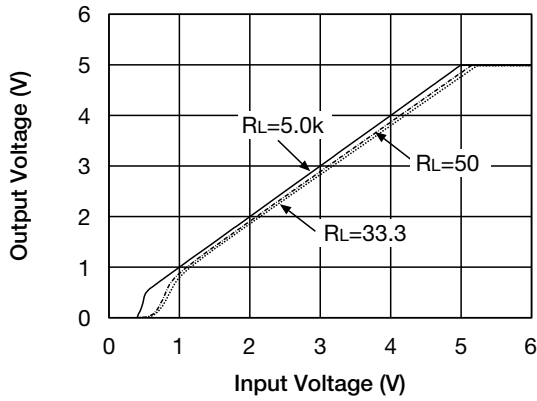

Input Voltage - Input Current

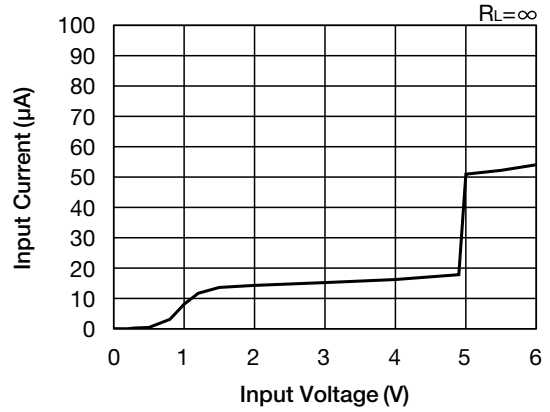

Load Regulation

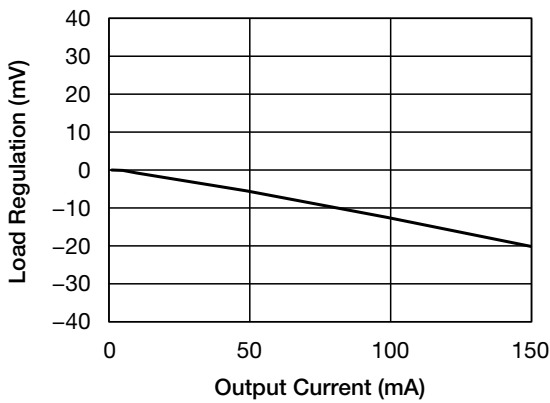

Line Regulation

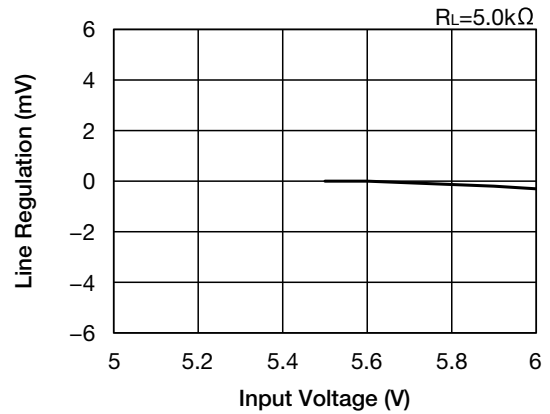

Dropout Voltage

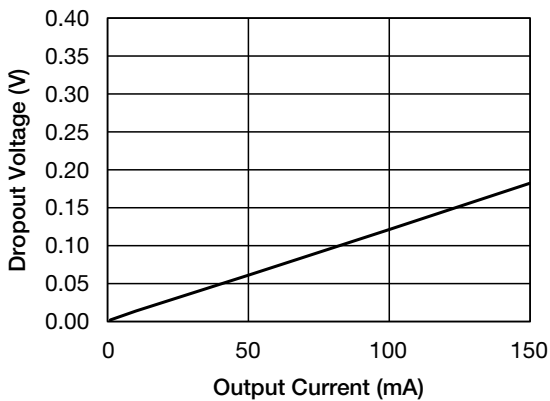

Ripple Rejection

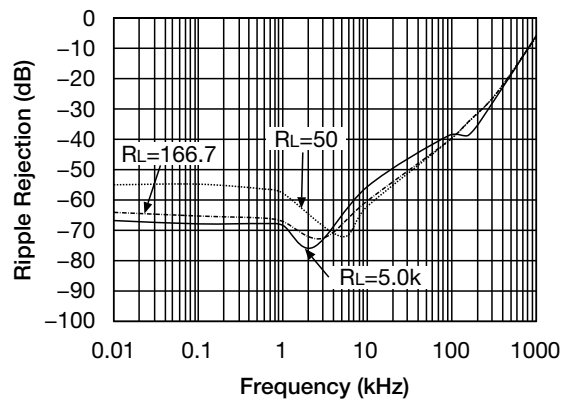

• Any products mentioned in this catalog are subject to any modification in their appearance and others for improvements without prior notification.
 • The details listed here are not a guarantee of the individual products at the time of ordering. When using the products, you will be asked to check their specifications.

■ Output Current - Output Voltage

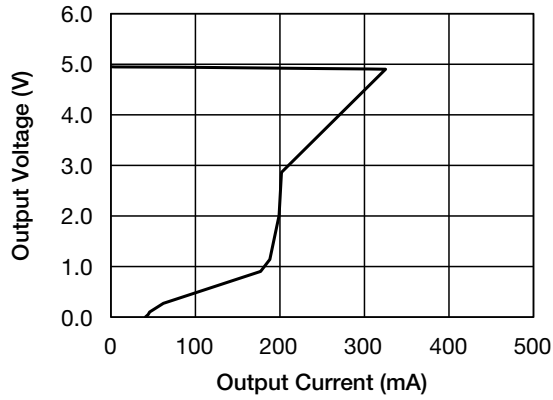

■ ESR stable area

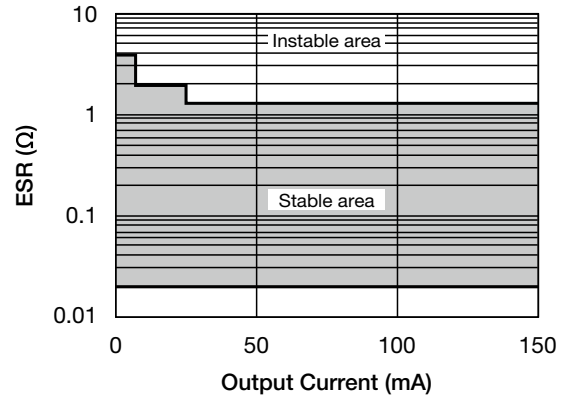

■ Output Voltage - Temperature Coefficient

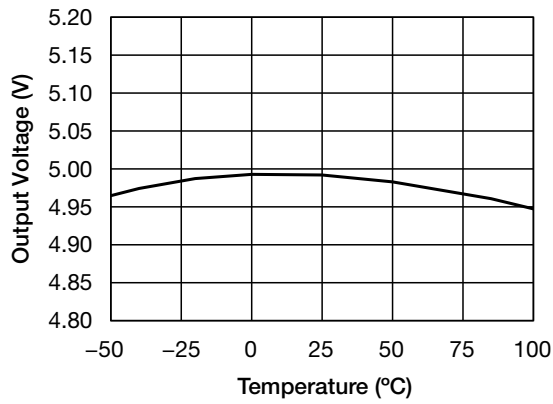

■ Output Noise Voltage

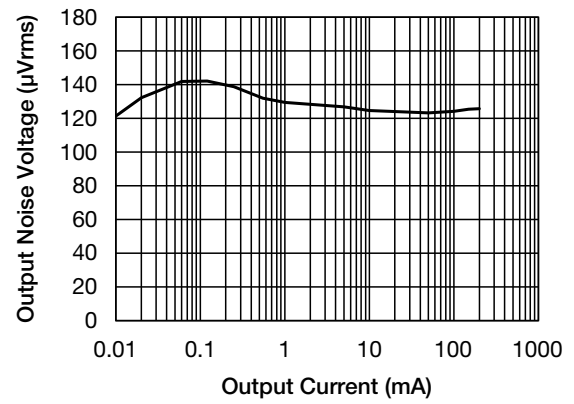

Load Transient response (VDD=6.0V)

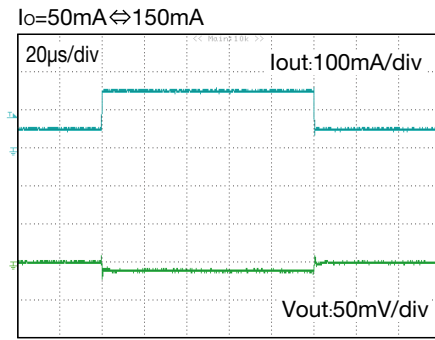

(VDD=5.5V)

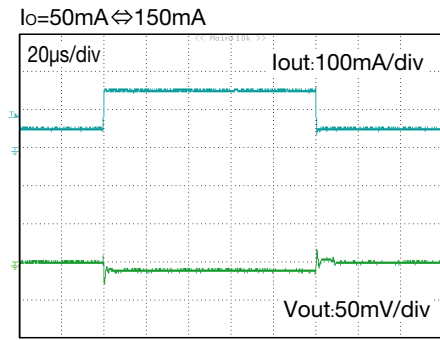

CE rise characteristics (VDD=6.0V)

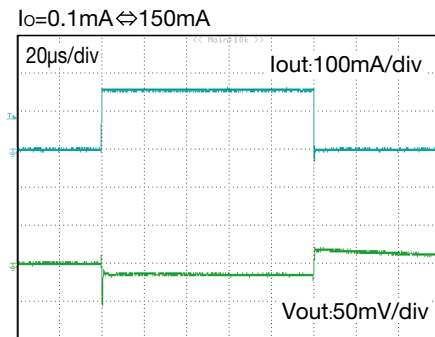

Vout discharge characteristics (VDD=5.5V)

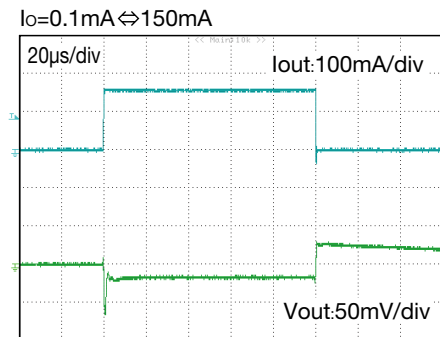

CE rise characteristics (VDD=6.0V, CE=0V→VDD)

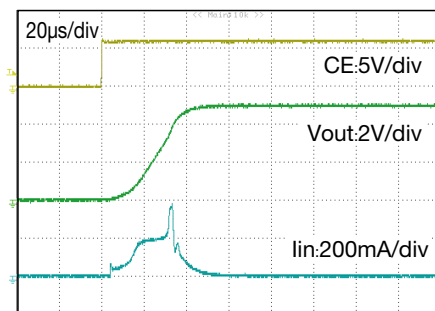

Vout discharge characteristics (VDD=6.0V, CE=VDD→0V)

