

BLDC 24P16A

9.1.040D

Brushless 3 – Phase DC Motor



Rated Voltage	No Load Speed	Rated Speed	Cont. Power	Rated Torque	Current at rated Speed	Efficiency at Duty Point
[V]	[rpm]	[rpm]	[W]	[mNm]	[A]	[%]
3	7.600	4.600	8	17	5,4	57
6	16.000	13.300	19	14	4,8	72

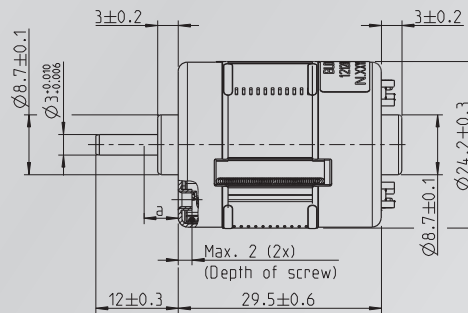
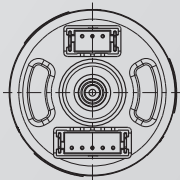

Motor Code: 121088800082

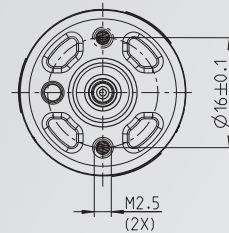

General informations

- **Class of protection:** IP20
- **Mounting position:** free
- **Duty cycle:** up to 100 %
- **Bearing system:** Ball Bearings
- **Torque Constant:** 3,2 mNm/A
- **Weight:** 0,05 kg
- **Rotor Inertia:** 2,3 gcm²
- **Oper. Temp. Range:** -20 °C to +45 °C
- **Max. Temp. Rise:** 70 K
- **Direction of Rotation:** CW / CCW
- **Class of Insulation:** H
- **Shaft Material:** Steel, not hardened
- **Number of Poles:** 6

Options

- **Integrated Drive Electro.:** No
- **Planetary Gearbox:** Yes
- **Sensorless Operation:** Yes
- **Shaft hardened (Surface):** Yes

Features

- High power-to-volume ratio
- High efficiency at duty point
- High reliability

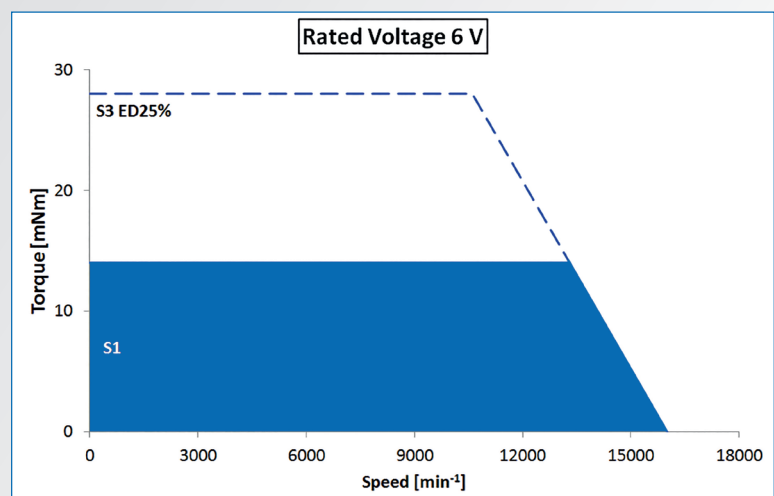

PM·DM

Minebea Group of Companies
 Minebea-Weg 1
 78052 Villingen-Schwenningen
 GERMANY
 www.pmdm.de
 Phone: +49 (0)7721 997-100
 E-Mail: sales@pmdm.de

Minebea
 Passion to Exceed Precision