



1cell Li-ion/Li-polymer battery protection IC

MM3860 series

Outline

MM3860 series are Li-ion battery protection IC and detect charge current / discharge current with high precision by current sensing resistor (Rsns). MM3860 have two step discharge overcurrent detection. And system is protected appropriately in the next 2 state, Normal discharge mode and large current discharge mode.

Features

(Unless otherwise specified, Ta=25 degC)

•Detection voltage	Range	Accuracy
Overcharge detection voltage	4.1V to 5.0V, 5mV steps	+/-20mV(Ta=-20 to +60 degC)
Overdischarge detection voltage	2.1V to 3.0V, 50mV steps	+/-35mV
Discharging overcurrent detection voltage 1	6mV to +50mV, 1mV steps	+/-1mV
Discharging overcurrent detection voltage 2	10mV to +100mV, 1mV steps	+/-2mV
Charging overcurrent detection voltage	-6mV to -50mV, 1mV steps	+/-1mV
Short detection voltage1	30mV to 200mV, 10mV steps	+/-5mV
0V battery charge inhibition battery voltage	0.9V fixed	+/-0.3V
•0V battery charge function	Selectable "Permission" or "inhibition"	
•Current consumption at Ta=25 degC		
Normal mode	2.5uA 4.0uA max.	
Standby mode	0.1uA max. (Overdischarge latch function enable.) 0.6uA max. (Overdischarge latch function disable.)	

Package type

•SON-6F	1.80 × 1.60 × 0.55 [mm]
•SSON-6J/6M	1.40 × 1.40 × 0.55 [mm]
•SSON-6U/6V	1.80 × 1.40 × 0.40 [mm]



Block Diagram

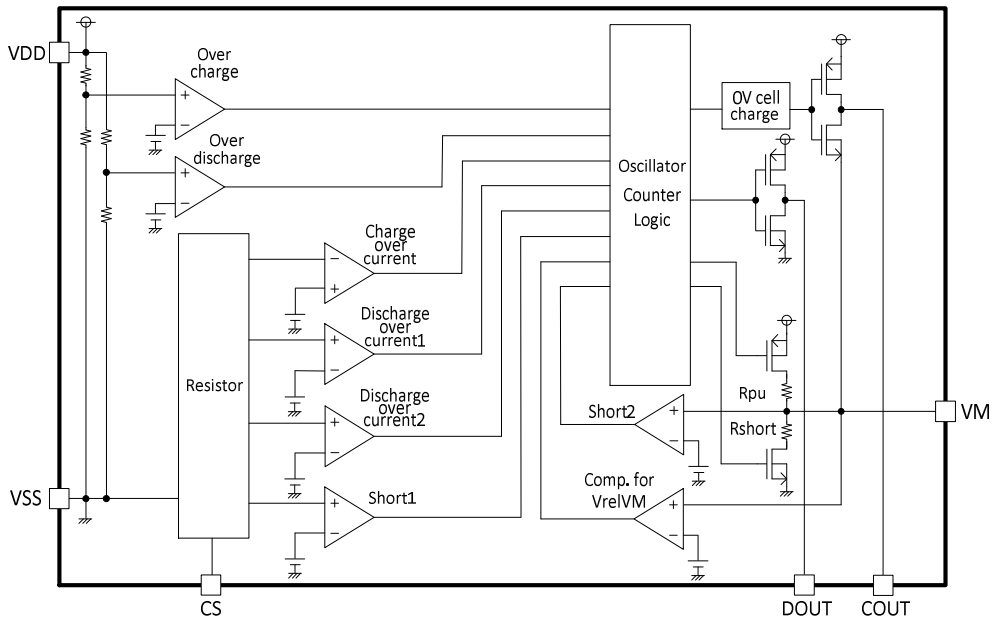

Package and pin configuration

SON-6F		Pin No.	Symbol	Function
	1	VM	Input terminal for charger negative voltage	
	2	COUT	Control terminal for charge FET	
	3	DOUT	Control terminal for discharge FET	
	4	VSS	Input terminal for negative power supply voltage	
	5	VDD	Input terminal for positive power supply voltage	
	6	CS	Input terminal for overcurrent detection	

SSON-6J/6M		Pin No.	Symbol	Function
	1	VSS	Input terminal for negative power supply voltage	
	2	VDD	Input terminal for positive power supply voltage	
	3	CS	Input terminal for overcurrent detection	
	4	VM	Input terminal for charger negative voltage	
	5	COUT	Control terminal for charge FET	
	6	DOUT	Control terminal for discharge FET	

SSON-6U/6V		Pin No.	Symbol	Function
	1	V-	Input terminal for charger negative voltage	
	2	COUT	Control terminal for charge FET	
	3	DOUT	Control terminal for discharge FET	
	4	VSS	Input terminal for negative power supply voltage	
	5	VDD	Input terminal for positive power supply voltage	
	6	CS	Input terminal for overcurrent detection	



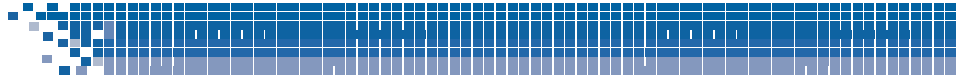

Package dimensions

Unit:mm

SON-6F

Top View

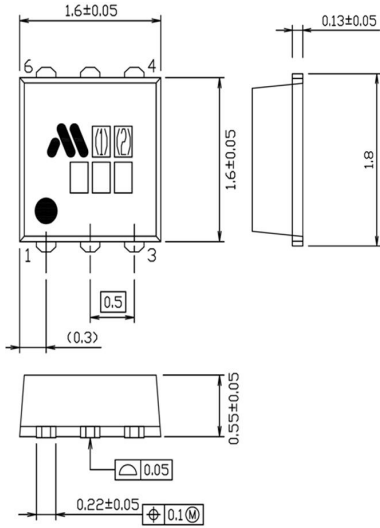

Bottom View

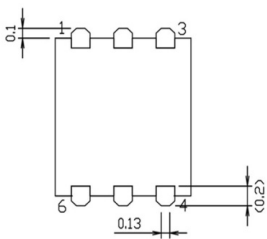

Marking Contents / SON-6F

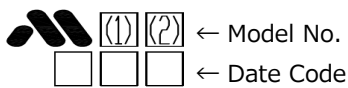

SSON-6J

Top View

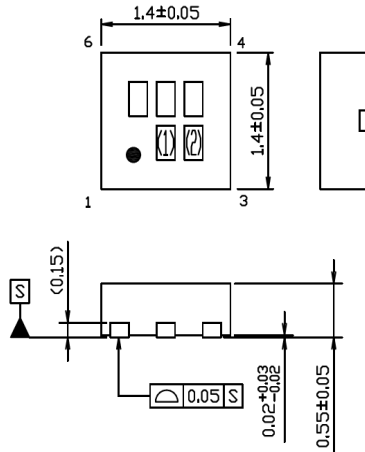

Bottom View

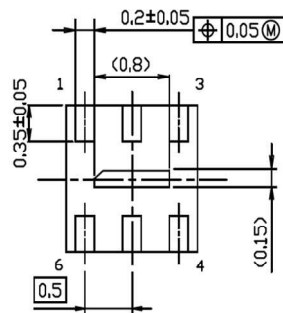

Marking Contents / SSON-6J

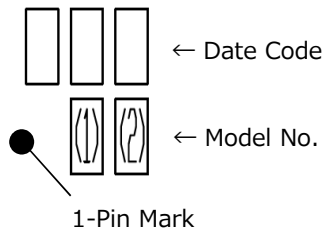

SSON-6M

Top View

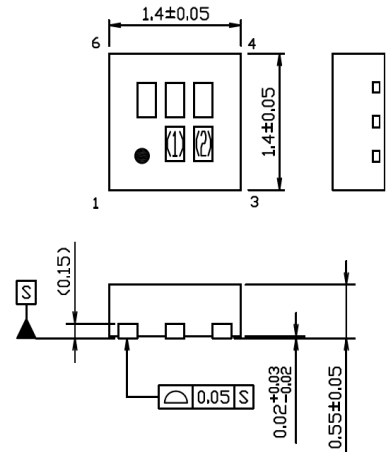

Bottom View

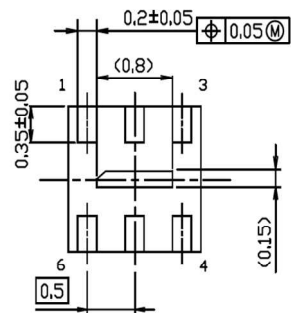

Marking Contents / SSON-6M

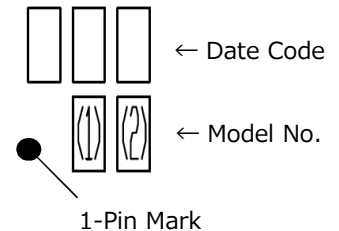

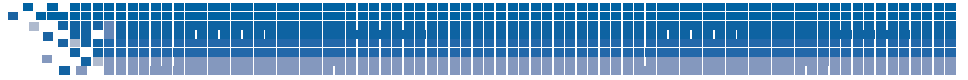

Package dimensions

Unit:mm

SSON-6U

Top View

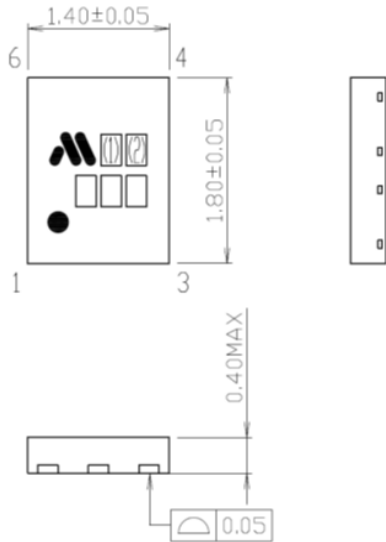

SSON-6V

Top View

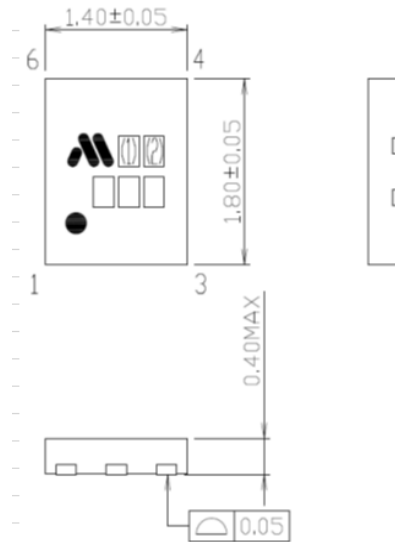

Bottom View

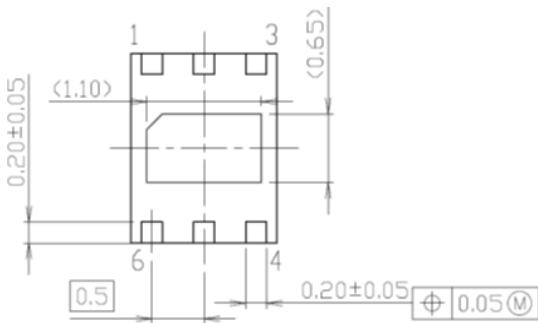

Bottom View

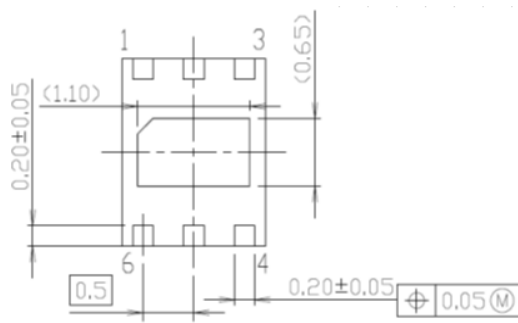

Marking Contents / SSON-6U

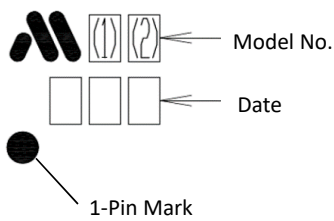

Marking Contents / SSON-6V

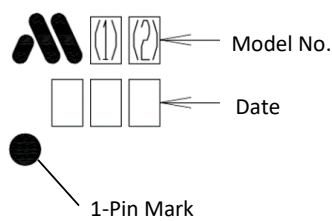



Absolute Maximum Ratings

Parameter	Symbol	Rating	Unit
Supply voltage	VDD	-0.3 to 12	V
V- terminal	V-	VDD-28 to VDD+0.3	V
COUT terminal	VCO	VDD-28 to VDD+0.3	V
DOUT terminal	VDO	-0.3 to VDD+0.3	V
CS terminal	VCS	-0.3 to VDD+0.3	V
Storage temperature	Tstg	-55 to +125	degC

Recommended Operating Conditions

Parameter	Symbol	Rating	Unit
Operating ambient temperature	Topr	-40 to +85	degC
Operating voltage	Vop	1.5 to 5.5	V

Electrical characteristics

(Unless otherwise specified, Ta=25 degC)

Parameter	Symbol	Condition	Min.	Typ.	Max.	Unit
Discharge overcurrent release resistance	Rshort	VDD=3.6V, V-=Vcs=1.0V	5.0	10.0	15.0	kohm
V- terminal pull-up resistances	Rpu	VDD=2.0V, V-=Vcs=0V	150	300	600	kohm
COUT L level output voltage	VcoL	VDD=4.5V, Icout=30uA	-	0.1	0.5	V
COUT H level output voltage	VcoH	VDD=4.0V, Icout=-30uA	VDD-0.5	VDD-0.1	-	V
DOUT L level output voltage	VdoL	VDD=2.0V, Idout=30uA	-	0.1	0.5	V
DOUT H level output voltage	VdoH	VDD=4.0V, Idout=-30uA	VDD-0.5	VDD-0.1	-	V
Current consumption	Idd	VDD=4.0V, V-=Vcs=0V	-	2.5	4.0	uA
Standby current	Is	VDD=2.0V, Vcs=0V, V-=VDD※1	-	-	0.1	uA
		VDD=2.0V, Vcs=0V, V-=VDD※2	-	0.3	0.6	

※1 Overdischarge latch function enable.

※2 Overdischarge latch function disable.





Electrical characteristics

(Unless otherwise specified, Ta=25 degC)

Parameter	Symbol	Condition	Min.	Typ.	Max.	Unit
Overcharge detection voltage	Vdet1	Ta=25 degC Ta=-20 to +60 degC	-0.020	Vdet1	+0.020	V
Overcharge release voltage	Vrel1		-0.030	Vrel1	+0.030	V
Overdischarge detection voltage	Vdet2		-0.035	Vdet2	+0.035	V
Overdischarge release voltage	Vrel2		-0.065	Vrel2	+0.090	V
Discharging overcurrent detection voltage 1	Vdet3-1	Ta=25 degC Ta=-20 to +60 degC	-1.0	Vdet3-1	+1.0	mV
			-1.5		+1.5	
Discharging overcurrent detection voltage 2	Vdet3-2	Ta=25 degC Ta=-20 to +60 degC	-2.0	Vdet3-2	+2.0	mV
			-2.5		+2.5	
Charging overcurrent detection voltage	Vdet4	Ta=25 degC Ta=-20 to +60 degC	-1.0	Vdet4	+1.0	mV
			-1.5		+1.5	
Short detection voltage 1	Vshort 1	Ta=25 degC Ta=-20 to +60 degC	-5.0	Vshort 1	+5.0	mV
			-5.5		+5.5	
Short detection voltage 2	Vshort 2		-0.300	VDD-0.9	+0.300	V
0V battery charge permission charger voltage	Vst		-	-	1.2	V
0V battery charge inhibition battery voltage	Vst		-0.300	0.900	+0.300	V
Monitor voltage for the charger connection	VrelVM		0.150	0.250	0.350	V
Release voltage from discharging overcurrent mode	VrelVM2	VDD=3.7V VCS=0V	-0.300	VDD-1.1	+0.300	V
Overcharge detection delay time	tVdet1		-20%	tVdet1	+20%	s
Overdischarge detection delay time	tVdet2		-20%	tVdet2	+20%	ms
Discharging overcurrent detection1 delay time	tVdet3-1		-20%	tVdet3-1	+20%	ms
Discharging overcurrent detection2 delay time	tVdet3-2		-20%	tVdet3-2	+20%	ms
Charging overcurrent detection delay time	tVdet4		-20%	tVdet4	+20%	ms
Short detection delay time	tshort		-30%	tshort	+40%	us



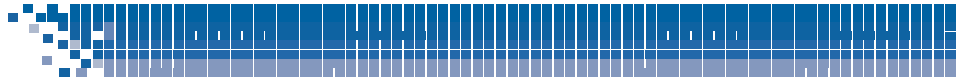

Typical application circuit

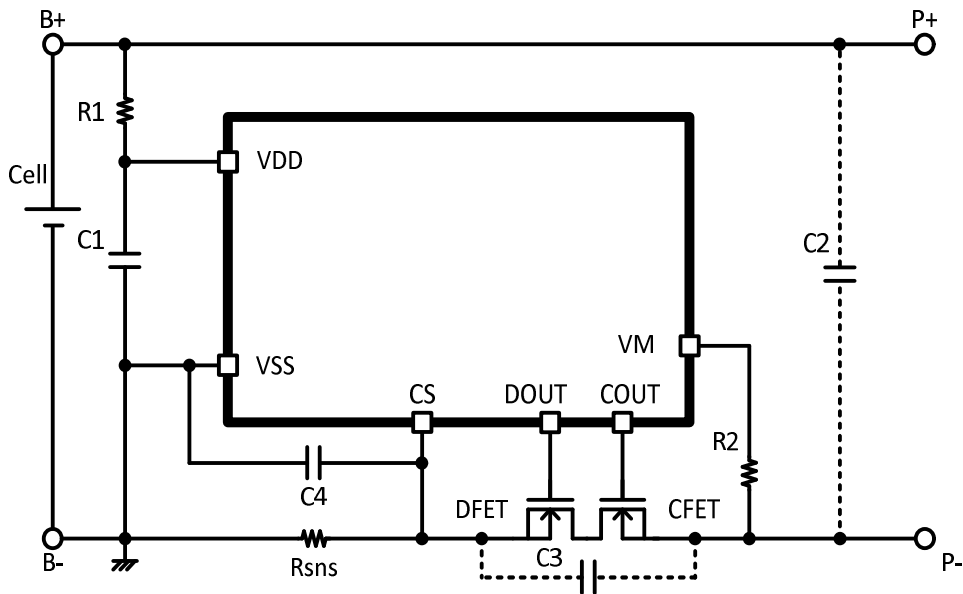

Unit:ohm ,F

Symbol	Part	Min.	Typ.	Max.	Purpose
R1	Resistor	-	100	1k	For voltage fluctuation and ESD
R2	Resistor	-	1k	10k	For current limit of charger reverse connection
Rsns	Resistor	-	-	-	Charge and discharge current sensing
C1	Capacitor	0.01u	0.1u	1.0u	For voltage fluctuation
C2	Capacitor	-	0.1u	-	For exogenous noise
C3	Capacitor	-	0.1u	-	For exogenous noise
C4	Capacitor	-	0.1u	-	For exogenous noise
DFET	Nch MOS FET	-	-	-	Charge and discharge control
CFET					

*The above application circuit and constant value do not guarantee proper operation.

*Please evaluate thoroughly by actual application to set up constants.



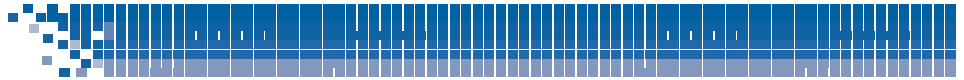

Lineup

MODEL	PKG	OV charge	Protection mode latch function			Hys-Cancel		Overcharge detection voltage	Overcharge release voltage	Overdischarge detection voltage	Overdischarge release voltage	Discharging overcurrent detection voltage	Discharging overcurrent detection voltage	Charging overcurrent detection voltage	Short detection voltage1	Delay time *1								
			Overcharge	Overdischarge	Discharge overcurrent	Overcharge	Overdischarge										Vdet1	Vrel1	Vdet2	Vrel2	Vdet3-1	Vdet3-2	Vdet4	Vshort1
																	[V]	[V]	[V]	[V]	[mV]	[mV]	[mV]	[mV]
MM3860AC5ZRE	SON-6F	0.9	Disable	Disable	Disable	Enable	Enable	4.475	4.275	2.500	2.900	7.0	-	-11.0	25.0	L								
MM3860AC6ZRE	SON-6F	0.9	Disable	Disable	Disable	Enable	Enable	4.520	4.320	2.300	2.500	7.0	-	-11.0	30.0	N								
MM3860AC7ZRE	SON-6F	0.9	Disable	Disable	Disable	Enable	Enable	4.540	4.340	2.300	2.500	7.0	-	-11.0	30.0	N								
MM3860ACAZRE	SON-6F	0.9	Disable	Disable	Disable	Enable	Enable	4.540	4.340	2.300	2.500	7.0	-	-13.0	30.0	N								
MM3860AF4RR4	SSON-6UorV	0.9	Disable	Disable	Disable	Enable	Enable	4.580	4.405	2.300	2.500	15.0	22.0	-20.0	40.0	O								
MM3860AF5RR4	SSON-6UorV	0.9	Disable	Disable	Disable	Enable	Enable	4.580	4.405	2.300	2.500	7.0	11.0	-13.0	22.0	O								
MM3860AL1ZRE	SON-6F	Permission	Disable	Disable	Disable	Enable	Enable	4.475	4.275	2.500	2.900	7.0	20.0	-7.0	70.0	A								
MM3860AL2ZRE	SON-6F	Permission	Disable	Disable	Disable	Enable	Enable	4.530	4.330	2.100	2.300	14.0	20.0	-20.0	55.0	B								
MM3860AL3ZRE	SON-6F	Permission	Disable	Disable	Disable	Enable	Enable	4.530	4.330	2.100	2.300	10.5	15.0	-15.0	40.0	B								
MM3860AL4ZRE	SON-6F	Permission	Disable	Disable	Disable	Enable	Enable	4.550	4.350	2.100	2.300	7.0	10.0	-10.0	27.0	B								
MM3860AL5ZRE	SON-6F	0.9	Disable	Disable	Disable	Enable	Enable	4.475	4.275	2.500	2.900	15.0	-	-15.0	32.0	C								
MM3860AL6ZRE	SON-6F	0.9	Disable	Disable	Disable	Enable	Enable	4.520	4.320	2.300	2.500	15.0	-	-15.0	36.0	D								
MM3860AL7ZRE	SON-6F	Permission	Disable	Disable	Disable	Enable	Enable	4.500	4.300	2.100	2.300	7.0	10.0	-13.0	27.0	B								
MM3860ALDZRE	SON-6F	Permission	Disable	Disable	Disable	Enable	Enable	4.530	4.330	2.350	2.550	21.0	33.0	-24.0	80.0	I								
MM3860ALEZRE	SON-6F	Permission	Disable	Disable	Disable	Enable	Enable	4.550	4.350	2.100	2.300	21.0	33.0	-30.0	80.0	I								
MM3860ALFZRE	SON-6F	Permission	Disable	Disable	Disable	Enable	Enable	4.530	4.330	2.350	2.550	7.0	12.0	-12.0	28.0	I								
MM3860ALGZRE	SON-6F	Permission	Disable	Disable	Disable	Enable	Enable	4.550	4.350	2.100	2.300	7.0	12.0	-14.0	28.0	I								
MM3860ALHZRE	SON-6F	Permission	Disable	Disable	Disable	Enable	Enable	4.250	4.150	2.800	3.000	35.0	55.0	-8.0	80.0	M								
MM3860ALJRR4	SSON-6UorV	Permission	Disable	Disable	Disable	Enable	Enable	4.555	4.380	2.600	2.800	15.0	22.0	-20.0	40.0	O								
MM3860ALKRR4	SSON-6UorV	Permission	Disable	Disable	Disable	Enable	Enable	4.555	4.380	2.600	2.800	7.0	11.0	-13.0	22.0	O								
MM3860AN1ZRE	SON-6F	Permission	Disable	Disable	Disable	Enable	Enable	4.445	4.245	2.500	2.900	21.0	-	-16.0	60.0	G								
MM3860AN2ZRE	SON-6F	Permission	Disable	Disable	Disable	Enable	Enable	4.480	4.380	2.300	2.700	23.0	-	-18.0	60.0	H								
MM3860AN3ZRE	SON-6F	Permission	Disable	Disable	Disable	Enable	Enable	4.445	4.245	2.500	2.900	21.0	-	-22.0	60.0	G								
MM3860AN4ZRE	SON-6F	Permission	Disable	Disable	Disable	Enable	Enable	4.480	4.380	2.300	2.700	23.0	-	-24.0	60.0	H								
MM3860AN5ZRE	SON-6F	Permission	Disable	Disable	Disable	Enable	Enable	4.445	4.245	2.500	2.900	11.0	-	-12.5	30.0	G								
MM3860AN6ZRE	SON-6F	Permission	Disable	Disable	Disable	Enable	Enable	4.480	4.380	2.300	2.700	13.0	-	-14.0	30.0	H								
MM3860AN7ZRE	SON-6F	Permission	Disable	Disable	Disable	Enable	Enable	4.480	4.380	2.300	2.700	7.0	-	-7.5	18.0	H								
MM3860AN8ZRE	SON-6F	Permission	Disable	Disable	Disable	Enable	Enable	4.450	4.250	2.500	2.900	14.5	22.0	-16.0	60.0	J								
MM3860AN9ZRE	SON-6F	Permission	Disable	Disable	Disable	Enable	Enable	4.485	4.385	2.300	2.700	14.5	24.0	-18.0	60.0	K								





Lineup

MODEL	PKG	OV charge	Protection mode latch function			Hys-Cancel		Overcharge detection voltage	Overcharge release voltage	Overdischarge detection voltage	Overdischarge release voltage	Discharging overcurrent detection voltage	Discharging overcurrent detection voltage	Charging overcurrent detection voltage	Short detection voltage1	Delay time *1								
			Overcharge	Overdischarge	Discharge overcurrent	Overcharge	Overdischarge										Vdet1	Vrel1	Vdet2	Vrel2	Vdet3-1	Vdet3-2	Vdet4	Vshort1
																	[V]	[V]	[V]	[V]	[mV]	[mV]	[mV]	[mV]
MM3860ANAZRE	SON-6F	Permission	Disable	Disable	Disable	Enable	Enable	4.450	4.250	2.500	2.900	7.5	12.0	-12.5	30.0	J								
MM3860ANBZRE	SON-6F	Permission	Disable	Disable	Disable	Enable	Enable	4.485	4.385	2.300	2.700	7.5	14.0	-14.0	30.0	K								
MM3860ANCZRE	SON-6F	Permission	Disable	Disable	Disable	Enable	Enable	4.490	4.290	2.500	2.900	11.0	-	-8.5	30.0	G								
MM3860ANDZRE	SON-6F	Permission	Disable	Disable	Disable	Enable	Enable	4.525	4.425	2.300	2.700	13.0	-	-10.0	30.0	H								
MM3860ANEZRE	SON-6F	Permission	Disable	Disable	Disable	Enable	Enable	4.490	4.290	2.500	2.900	11.0	-	-12.5	30.0	G								
MM3860ANFZRE	SON-6F	Permission	Disable	Disable	Disable	Enable	Enable	4.525	4.425	2.300	2.700	13.0	-	-14.0	30.0	H								
MM3860ANGZRE	SON-6F	Permission	Disable	Disable	Disable	Enable	Enable	4.490	4.290	2.500	2.900	7.5	12.0	-8.5	30.0	P								
MM3860ANHZRE	SON-6F	Permission	Disable	Disable	Disable	Enable	Enable	4.525	4.425	2.300	2.700	7.5	14.0	-10.0	30.0	K								
MM3860ANJZRE	SON-6F	Permission	Disable	Disable	Disable	Enable	Enable	4.490	4.290	2.500	2.900	7.5	12.0	-12.5	30.0	P								
MM3860ANKZRE	SON-6F	Permission	Disable	Disable	Disable	Enable	Enable	4.525	4.425	2.300	2.700	7.5	14.0	-14.0	30.0	K								
MM3860BC3ZRE	SON-6F	0.9	Disable	Disable	Disable	Enable	Enable	4.495	4.295	2.500	2.900	7.0	-	-11.0	25.0	L								

*1 Delay time

	t Vdet1 [s]	t Vrel1 [ms]	t Vdet2 [ms]	t Vrel2 [ms]	t Vdet3-1 [ms]	t Vdet3-2 [ms]	t Vrel3 [ms]	t Vdet4 [ms]	t Vrel4 [ms]	t short [us]
A	1.024	1.00	64.00	1.00	4096.00	16.00	8.00	16.00	4.00	280
B	1.024	1.00	64.00	1.00	3584.00	16.00	8.00	16.00	1.00	280
C	1.024	1.00	32.00	1.00	64.00	-	8.00	16.00	4.00	250
D	1.024	1.00	64.00	1.00	128.00	-	8.00	64.00	4.00	250
E	1.024	16.00	20.00	1.00	12.00	-	2.00	16.00	1.00	250
F	1.024	16.00	32.00	1.00	3584.00	32.00	8.00	32.00	1.00	250
G	1.024	16.00	128.00	4.00	16.00	-	4.00	8.00	4.00	280
H	1.024	16.00	128.00	1.00	32.00	-	4.00	32.00	4.00	530
I	1.024	1.00	64.00	1.00	3584.00	16.00	8.00	16.00	4.00	280
J	1.024	16.00	128.00	4.00	3584.00	16.00	4.00	8.00	4.00	280
K	1.024	16.00	128.00	1.00	3584.00	32.00	4.00	32.00	4.00	530
L	0.512	1.00	64.00	1.00	128.00	-	8.00	32.00	1.00	280
N	1.024	1.00	64.00	1.00	256.00	-	8.00	64.00	1.00	280
M	1.024	16.00	128.00	1.00	2048.00	4.00	2.00	16.00	1.00	280
O	1.024	1.00	64.00	1.00	3072.00	256.00	8.00	16.00	4.00	280
P	1.024	16.00	128.00	4.00	2048.00	16.00	4.00	8.00	4.00	280
Q	1.024	1.00	32.00	1.00	16.00	-	1.00	16.00	1.00	250
R	1.024	16.00	20.00	1.00	12.00	-	1.00	16.00	1.00	250
S	1.024	16.00	32.00	1.00	20.00	-	1.00	32.00	1.00	500
T	1.024	16.00	96.00	4.00	12.00	-	2.00	8.00	4.00	250
U	2.048	16.00	128.00	4.00	512.00	-	8.00	32.00	8.00	400

