



Precision Adjustable Shunt Regulator

MM1530 series

Outline

This IC is 3-terminal adjustable shunt regulator, which provides a high accuracy bandgap reference voltage. The output voltage can be adjusted to any value between reference voltage V_{Ref} and 12V with two external resistors. Moreover, there are a lot of ranges of the application as a zener diode besides the replacement is possible because it has steep turn-on characteristics

Features

- High accuracy reference voltage
- Programmable output voltage
- Low dynamic impedance

Specification

(Unless otherwise specified, $T_a=25^\circ\text{C}$)

Item	MM1530CURE	MM1530DURE	MM1530DNRE	MM1530ENRE	MM1530JNRE
Cathode to Anode voltage	V_{Ref} to 12V	V_{Ref} to 12V	V_{Ref} to 12V	V_{Ref} to 12V	V_{Ref} to 13V
Cathode current	0.3mA to 15mA	0.3mA to 30mA	0.3mA to 30mA	0.3mA to 15mA	0.08mA to 30mA
Operating ambient temperature	-30°C to 105°C	-30°C to 105°C	-30°C to 105°C	-30°C to 105°C	-30°C to 105°C
Reference voltage (Typ.)	1.270V	1.250V	1.240V	1.270V	1.240V
Reference voltage accuracy	$\pm 0.8\%$	$\pm 0.8\%$	$\pm 0.5\%$	$\pm 0.8\%$	$\pm 0.5\%$
Reference input current (Typ.)	2 μA	2 μA	2 μA	2 μA	2 μA
Minimum operating current (Typ.)	0.15mA	0.15mA	0.15mA	0.15mA	0.05mA
Off-state cathode current (Typ.)	0.1 μA	0.1 μA	0.1 μA	0.1 μA	0.1 μA
Dynamic impedance (Typ.)	0.4 Ω	0.4 Ω	0.2 Ω	0.4 Ω	0.2 Ω
Package	SC-82ABB	SC-82ABB	SOT-23A	SOT-23A	SOT-23A

Block diagram

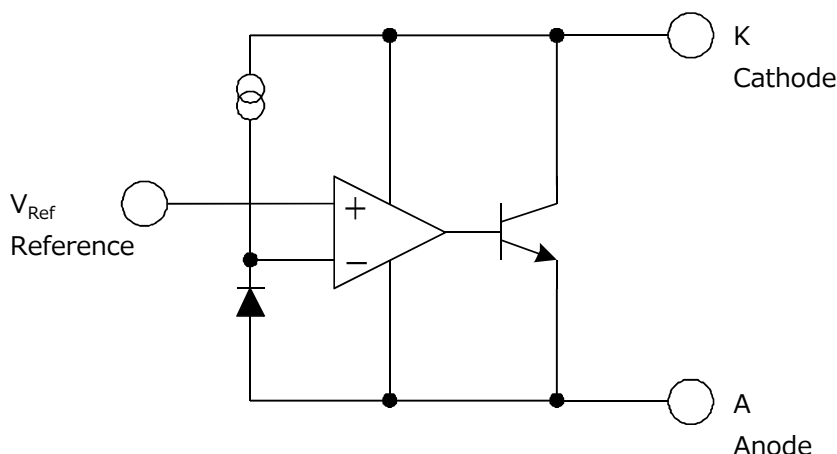

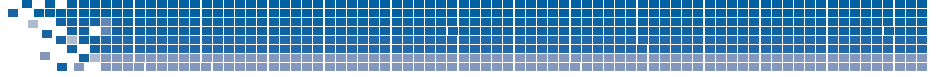

Package and pin configuration

- SC-82ABB (MM1530CU, MM1530DU)

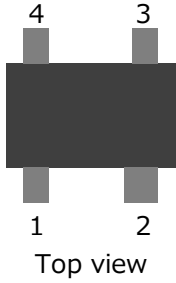

Pin No.	Symbol	Function
1	N.C.	N.C. terminal
2	A	Anode terminal
3	K	Cathode terminal
4	V_{Ref}	Reference terminal

- SOT-23A (MM1530DN, MM1530EN, MM1530JN)

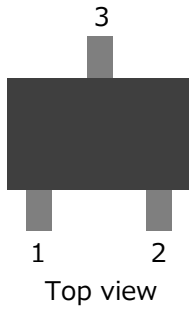

Pin No.	Symbol	Function
1	V_{Ref}	Reference terminal
2	K	Cathode terminal
3	A	Anode terminal





Absolute Maximum Ratings

Item	Symbol	Ratings	Unit	
Cathode to Anode voltage	V_{KA}	MM1530JN	13	V
		Other products	12	
Cathode current	I_K	50	mA	
Anode to Cathode Current	$-I_K$	-30	mA	
Reference input voltage	V_{Ref}	7	V	
Reference input current	I_{Ref}	10	mA	
Storage temperature	T_{stg}	-40 to +125	°C	
Power dissipation	P_d	150 (ALONE)	mW	

Recommended Operating Conditions

Item	Symbol	Min.	Max.	Unit	
Cathode to Anode voltage	V_{KA}	V_{Ref}	12	V	
Cathode current	I_K	MM1530CU, MM1530EN	0.3	15	mA
		MM1530DU, MM1530DN	0.3	30	
		MM1530JN	0.08	30	
Operating temperature	T_{opr}	-30	+105	°C	
Junctin temperature	T_j	-30	+125	°C	

Electrical characteristics

(Unless otherwise specifide, $I_K=10mA$, $T_a=25^\circ C$)

Item	Symbol	Conditions	Min.	Typ.	Max.	Unit	
Reference voltage	V_{Ref}	$V_{KA}=V_{Ref}$	MM1530CU, MM1530EN	1.260	1.270	1.280	V
			MM1530DU	1.240	1.250	1.260	
			MM1530DN	1.234	1.240	1.246	
		$V_{KA}=V_{Ref}$ $I_K=1mA$	MM1530JN	1.234	1.240	1.246	
Reference voltage deviation over temperature range	$\Delta V_{Ref} / \Delta T_a$	$V_{KA}=V_{Ref}$, $T_a=0^\circ C$ to $70^\circ C$	MM1530CU, MM1530EN	-	3	12	mV
			MM1530DU, MM1530DN, MM1530JN	-	6	12	
Reference voltage change with operating voltage change	$\Delta V_{Ref} / \Delta V_{KA}$	$V_{Ref} \leq V_{KA} \leq 5V$	-	1.0	2.7	mV/V	
		$5V \leq V_{KA} \leq 12V$	-	1.0	2.0		
Reference voltage change with operating current change	$\Delta V_{Ref} / \Delta I_{KA}$	$V_{KA}=V_{Ref}$, $I_{KA}=1mA$ to $10mA$	-	3	5	mV	
Reference input current	I_{Ref}	$V_{KA}=V_{Ref}$, $R1=10K\Omega$, $R2=\infty$		2	4	μA	
Reference input current deviation over temperature range	$\Delta I_{Ref} / \Delta T_a$	$V_{KA}=V_{Ref}$, $R1=10K\Omega$, $R2=\infty$, $T_a=0^\circ C$ to $70^\circ C$		0.3	1.2	μA	



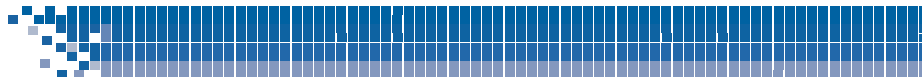

Electrical characteristics

(Unless otherwise specified, $I_K=10\text{mA}$, $T_a=25^\circ\text{C}$)

Item	Symbol	Conditions	Min.	Typ.	Max.	Unit	
Minimum operating current	I_{Kmin}	$V_{KA}=V_{Ref}$, $\Delta V_{Ref}=2\%$	MM1530CU, MM1530DU, MM1530DN, MM1530EN	-	0.15	0.3	mA
			MM1530JN	-	0.05	0.08	
Off-state Cathode current	I_{Koff}	$V_{KA}=12\text{V}$, $V_{Ref}=0\text{V}$	-	0.1	1	μA	
Dynamic impedance	$ Z_{KA} $	$V_{KA}=V_{Ref}$, $f\leq 1\text{kHz}$, $1\text{mA}\leq I_K\leq 30\text{mA}$	MM1530CU, MM1530DU, MM1530EN	-	0.4	0.8	Ω
			MM1530DN	-	0.2	0.6	
		$V_{KA}=V_{Ref}$, $f\leq 1\text{kHz}$, $1\text{mA}\leq I_K\leq 15\text{mA}$	MM1530JN	-	0.2	0.6	

*Note1: $V_{out} \doteq ((1+R1/R2) \times V_{Ref} + I_{Ref} \times R1) / (k \times (1+R1/R2) \times V_{Ref} + 1)$

*Note2: The output voltage is influenced by the current of the base as shown in the above expression, and use R1 and R2 with 10k Ω or less, please. Or, select an appropriate constant according to the demanded accuracy.

*Note3: When the outside putting resistance of the following is used, the output voltage is shown by the next expression.

$$V_{out} = \Delta V_{out} + (1 + R1/R2) \times V_{Ref}$$

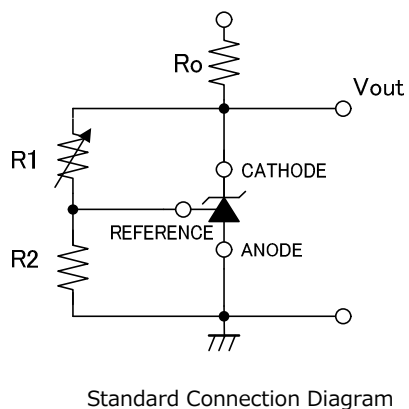
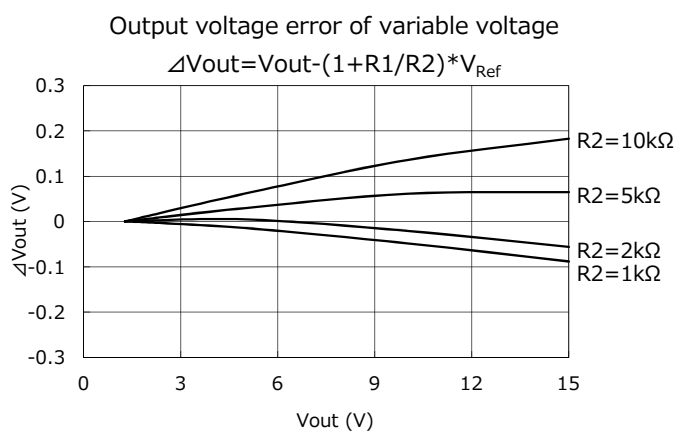

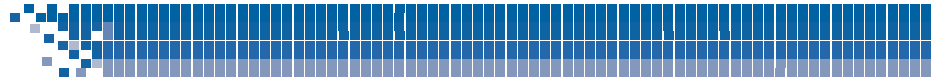

Test circuit

1) Reference Voltage Test Circuit

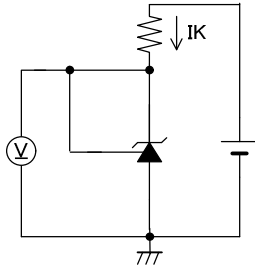

2) Reference Voltage Change with Operating current Test Circuit

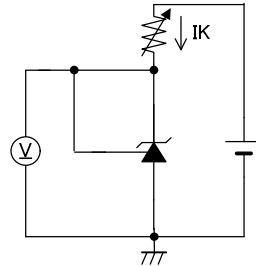

3) Reference Voltage Change with Operating Voltage Change Test Circuit

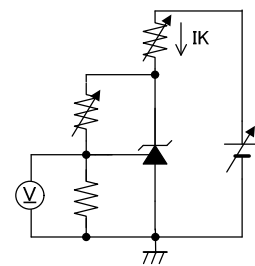

4) Reference Input Current Test Circuit

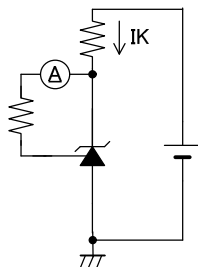

5) Minimum Operating Current Test Circuit

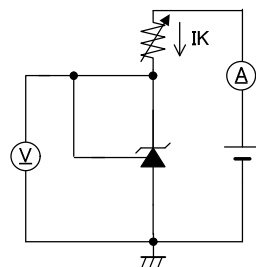

6) Off-Stage Cathode Current Test Circuit

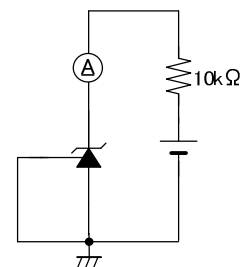

7) Dynamic Impedance vs. Freq Test Circuit

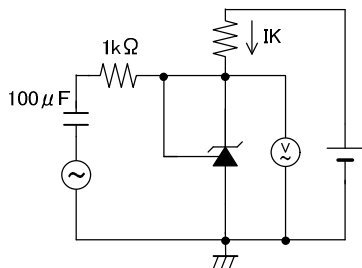

8) Response Test Circuit

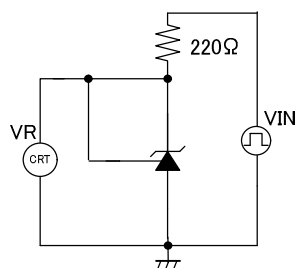

9) Open Loop Gain vs. Freq Test Circuit

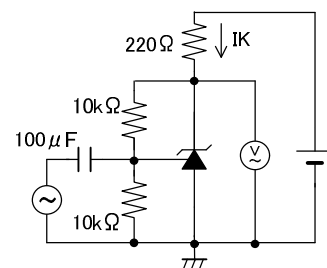

10) Stability Boundary Condition Test Circuit

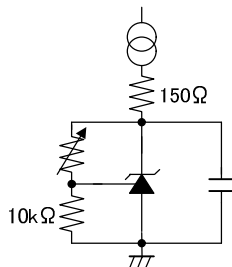

11) Standard Conneciton Diagram

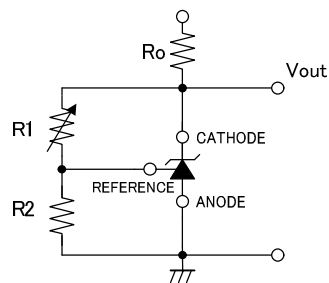

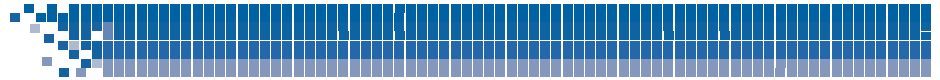

Typical performance characteristics

1-1) Reference voltage deviation over temperature range
(MM1530CU,MM1530EN)

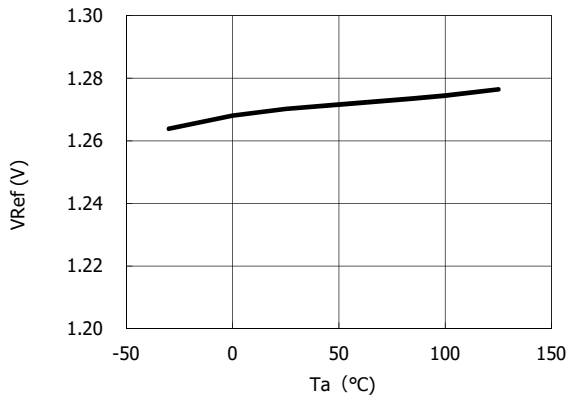

1-2) Reference voltage deviation over temperature range
(MM1530DU)

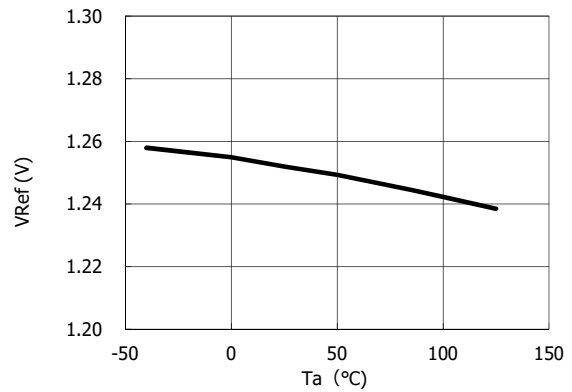

1-3) Reference voltage deviation over temperature range
(MM1530DN,MM1530JN)

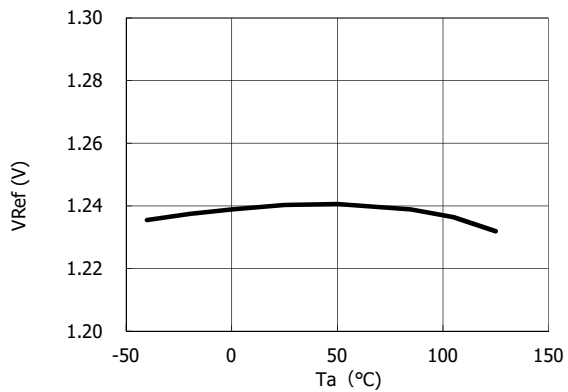

2) Reference input current deviation over temperature range

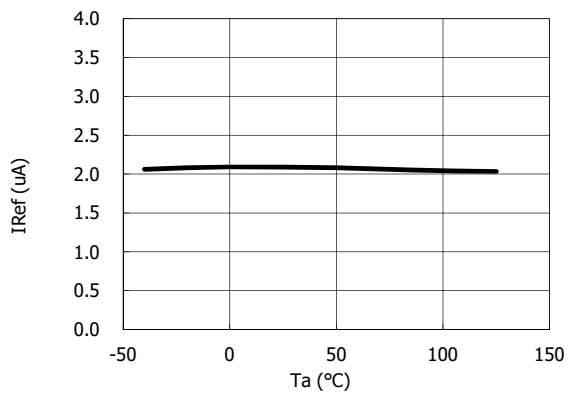

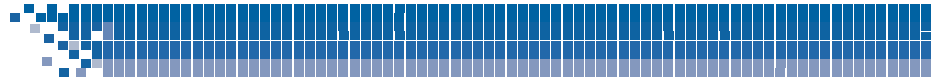

Typical performance characteristics

3-1) Reference voltage change with operating voltage change
(MM1530CU,MM1530EN)

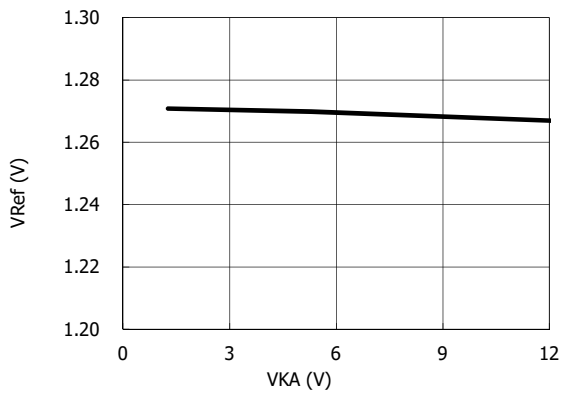

3-2) Reference voltage change with operating voltage change
(MM1530DU)

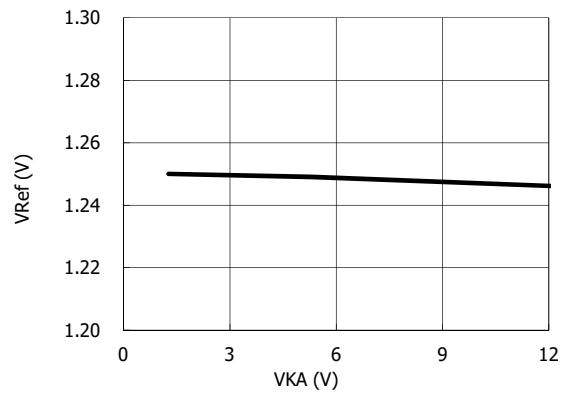

3-3) Reference voltage change with operating voltage change
(MM1530DN,MM1530JN)

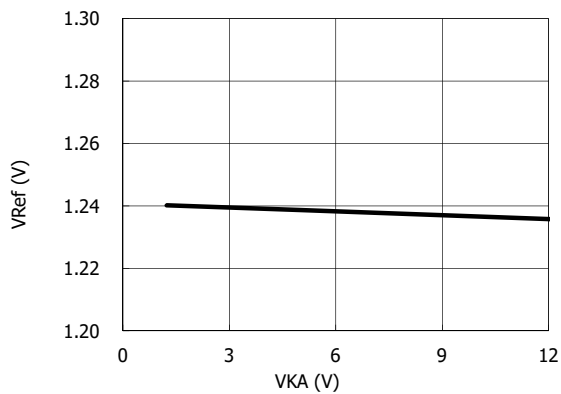

4-1) Minimum operating current
(MM1530CU,MM1530DU,MM1530DN,MM1530EN)

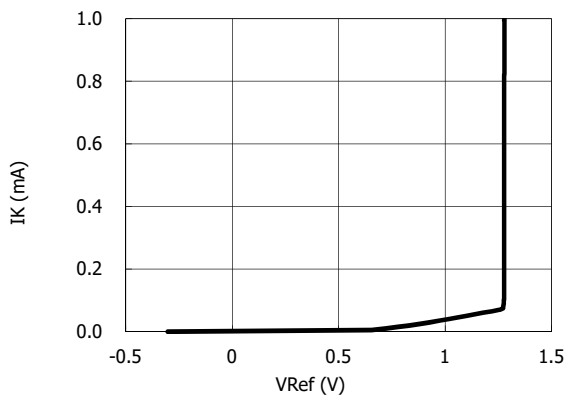

4-2) Minimum operating current
(MM1530JN)

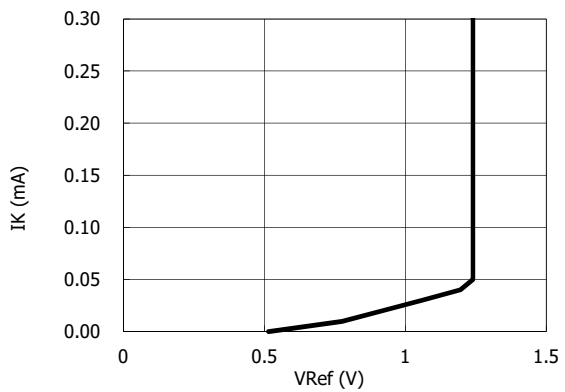

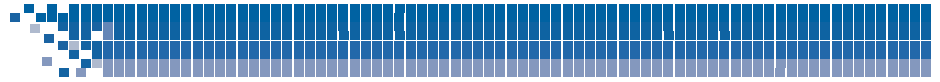

Typical performance characteristics

5) Load regulation

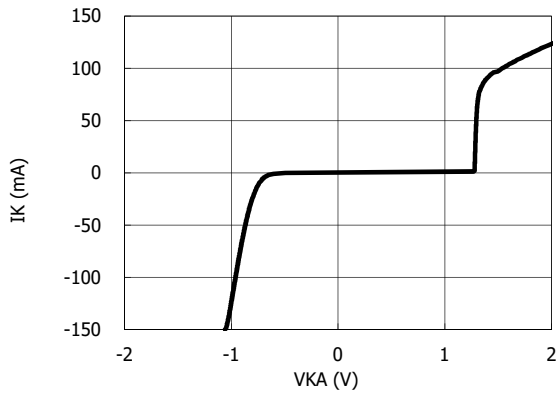

6) Response $I_K=10mA$

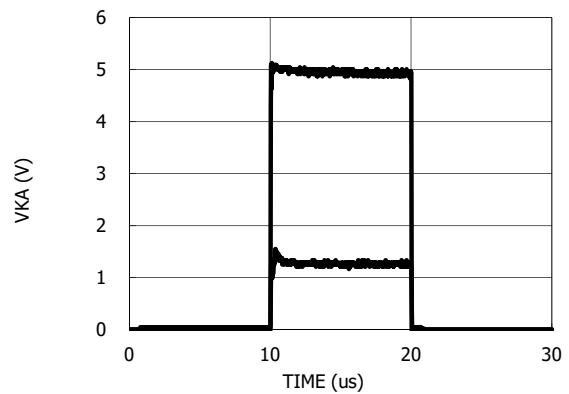

7) Off-state Cathode current change with operating temperature change

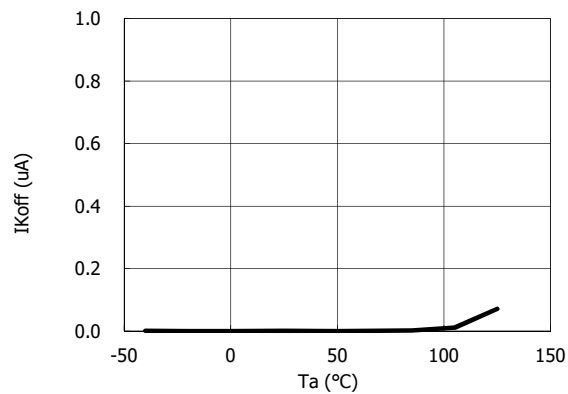

8) Off-state Cathode current change with operating voltage change

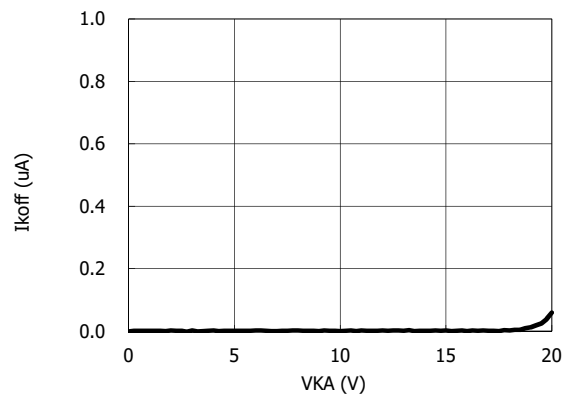

9) f-Av, ϕ

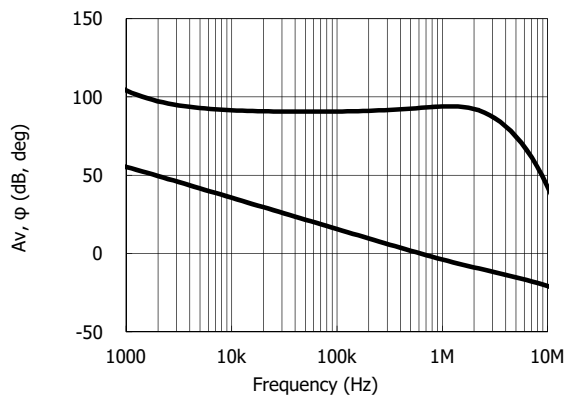

10) Stability boundary conditions

