

# PWM and IP Protected DC Fan 12038VE-24 (E-Type)

NMB

## General Specifications

### Motor Type:

DC Brushless Motor

### Motor Protection:

Auto Restart / Polarity Protection (Motor withstands reverse connection for positive and negative leads.)

### Insulation Resistance:

10MΩ or over with a DC 500V Megger

### Dielectric Withstand Voltage:

AC 500V 1min or AC 700V 1sec

### Allowable Ambient Temperature Range:

-10°C ~ + 60°C (Operating)

-40°C ~ + 70°C (Storage)

(non-condensing environment)

*\*For reference only. Please see fan outline for details*

## Characteristic Curves

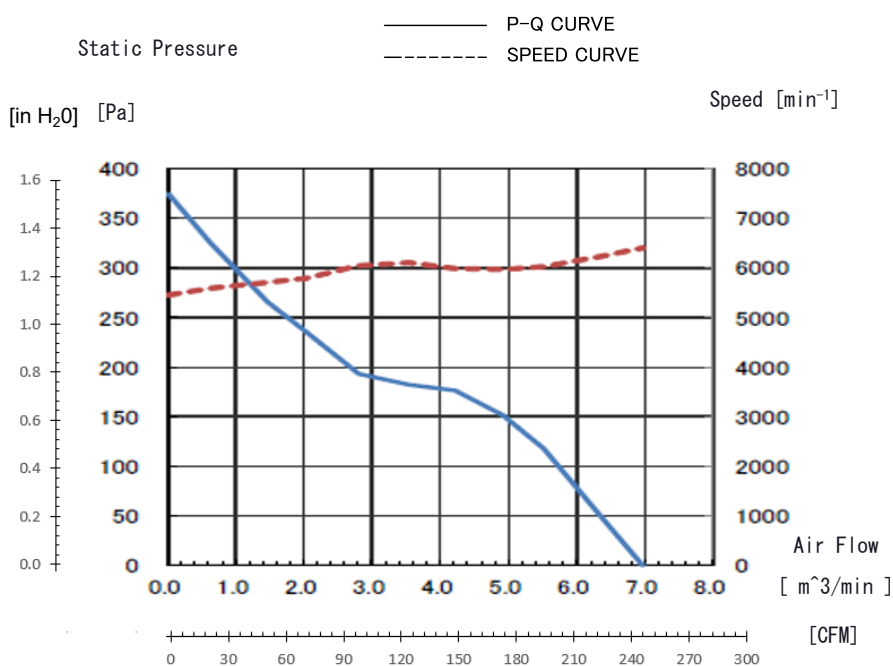

## Features

- DC axial fan with outstanding P-Q performance, PWM speed control, tach output and IP68 potting
- Vertically integrated manufacturing, with components made in-house
- IP68 potting offers highest level of protection from water/dust ingress
- Outfitted with NMB precision machined stainless steel ball bearings for long life
- Ideal for applications such as EV chargers, PV inverters, telecom cabinets, small cell 5G network and outdoor applications

## Life Expectancy L10

40,000 Hours at 60 Celsius

*\*Fan life expectation is based on free air operation at 60°C, rated voltage, and indoor benign lab environment*

*\*1: Values in Free Air*

## Specifications

MODEL	Rating Voltage (V)	Operating Voltage (V)	Current		Input Power		Speed Inlet/Outlet RPM	Max. Air Flow		Max. Static Pressure		Noise (dB) <sup>*1</sup>	Mass (g)
			Avg (A) <sup>*1</sup>	Max (A) <sup>*1</sup>	Avg (W) <sup>*1</sup>	Max (W) <sup>*1</sup>		(CFM)	(m <sup>3</sup> /min)	(in H <sub>2</sub> O)	(Pa)		
12038VE-24R-GUE-2	24	18.0 to 24.6	1.6	2.00	38.4	48.0	6,400	243.67	6.90	1.5	370	66	370

# PWM and IP Rated DC Fan 12038VE-24R (E-Type)



## PWM Specifications

### Connection

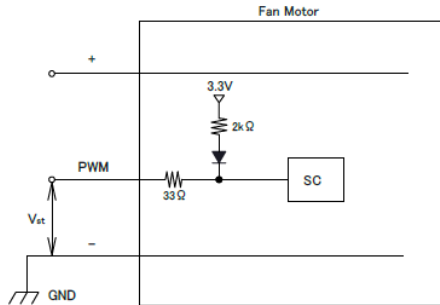

#### 1. PWM Control

- Vst = Low Level (0V~0.4V) → Stop (On Duty 0%)
- Vst = High Level (4.0V~5.0V) → Full Speed (On Duty 100%)
- Vst = Open → Full Speed

#### 2. PWM Duty & PWM Input Pulse

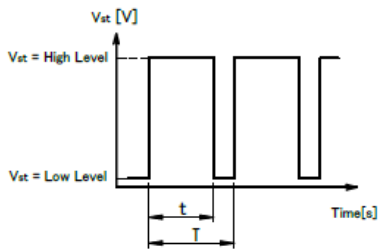

PWM Duty means that a ratio of high level time (t)/PWM Input Pulse(T).

$$(t/T) \times 100 : \text{On Duty } 0\% \sim 100\%$$

$$\text{PWM Frequency } f = 25[\text{kHz}]$$

#### 3. The condition for PWM control are as follows

- When you use this under PWM control, always be sure the motor's operation under practical mounting state. Fan motor may not start up caused by PWM control at very low speed condition.
- To run at Rating Voltage
- Please use the start with Duty 20% or more at 25kHz.[At rated voltage input, Ambient temperature 25°C]

## PWM Characteristic Curve

Reference PWM Duty VS Speed  
Conditions : at Rating Voltage, Vst=5.0V,  
f=25kHz, Ta=25°C

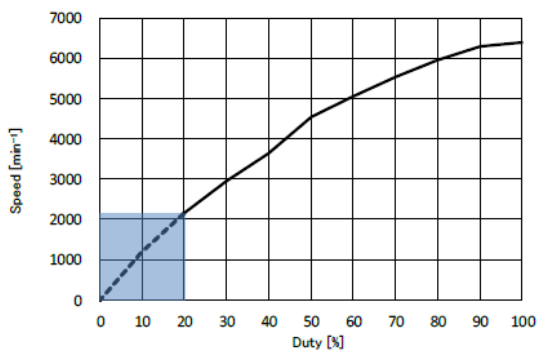

## TACHO Specifications

### Tachometer Signal

1. Output Circuit: Open Drain
2. Specification  
Absolute Maximum Ratings at Ta=25°C  
V<sub>DSmax</sub>: +30V  
I<sub>Dmax</sub>: 5mA[V<sub>DS(sat)</sub>max=1.5V]

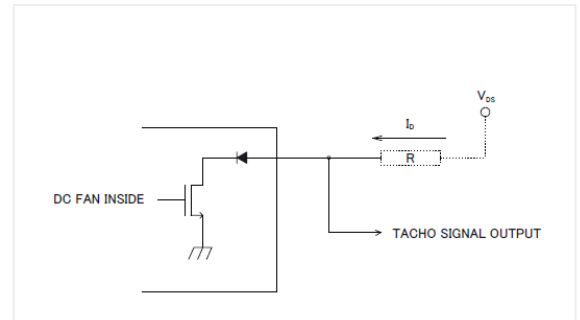

#### 3. Output Waveform: At Rated Voltage Output Signal Voltage

##### Case-1

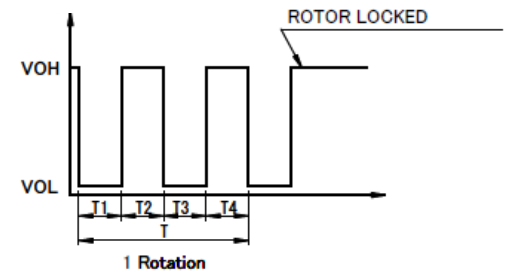

##### Case-2

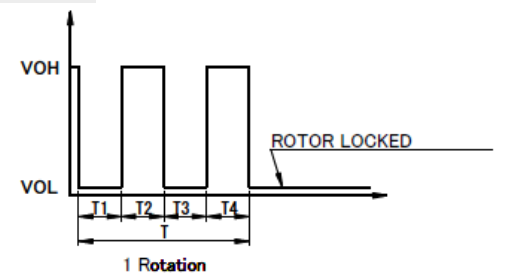

- 1) When the rotor is locked at VOH position of signal, signal keeps VOH position.
- 2) When the rotor is locked at VOL position of signal, signal keeps VOL position.
- 3)  $T = T1 + T2 + T3 + T4 = 60/m = 1 \text{ rotation}$

m: Fan Speed (min<sup>-1</sup>)

Tacho Duty Cycle=50%±10%

# PWM and Tach Output DC Fan with Potting 12038VE-24R (E-Type)

**NMB**

## Outlines

(Name Plate)

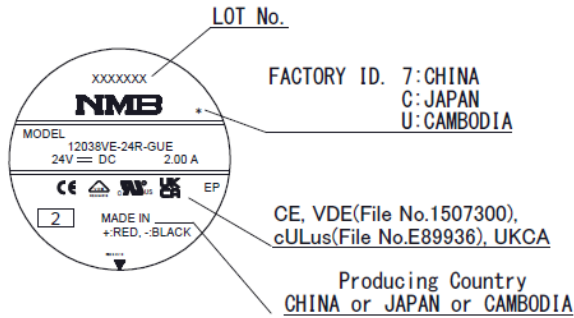

## Materials

**Casing:** Plastic (Black UL 94V-0)

**Impeller:** Plastic (Black UL 94V-0)

**Bearing:** Stainless Steel Ball Bearing

**Lead Wire:** UL3443 AWG24 for

Red (+)  
Black (-)  
White (Tach)  
Brown (PWM)

(Outline)

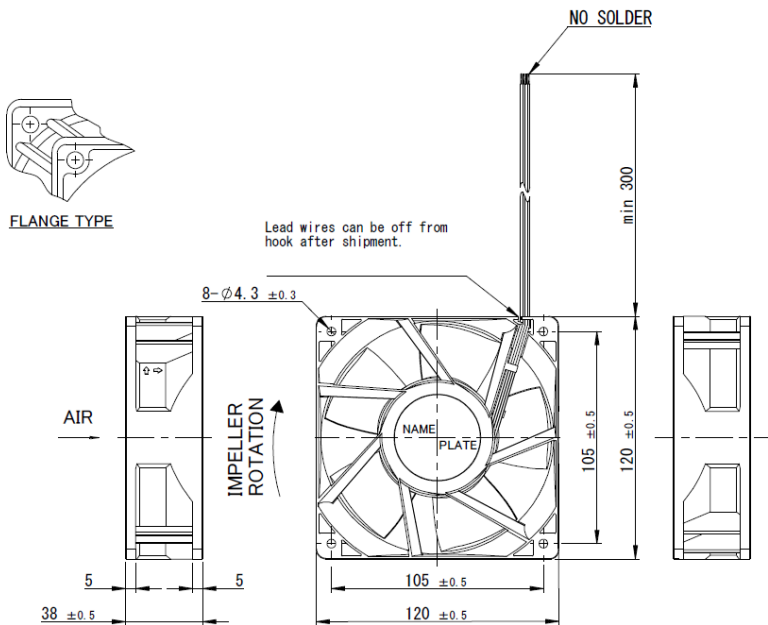

(Panel Out-line)

