



1cell Li-ion/Li-polymer battery protection IC

MM3832 series

Outline

MM3832 series are Li-ion battery protection IC and detect charge current / discharge current with high precision by current sensing resistor (Rsns). The overcharge, overdischarge, discharging overcurrent, short, charging overcurrent, and over voltage charger protection of the Li-ion battery can be detected.

Features

(Unless otherwise specified, Ta=25 degC)

•Detection voltage	Range	Accuracy
Overcharge detection voltage	4.2V to 4.8V, 1mV steps	+/-10mV
Overdischarge detection voltage	2.0V to 3.4V, 5mV steps	+/-35mV
Discharging overcurrent detection voltage	10mV to +150mV, 1mV steps	+/-2mV
Charging overcurrent detection voltage	-10mV to -150mV, 1mV steps	+/-3mV
Short detection voltage	40mV to 300mV, 5mV steps	+/-3mV
0V battery charge inhibition battery voltage	1.25V to 2.00V, 0.05V steps	+/-0.05V(Ta=0 to +50 degC)

•0V battery charge function	Selectable "Permission" or "inhibition"
-----------------------------	---

•Current consumption at Ta=-40 to 25 degC	
Normal mode	3.0uA typ. 6.0uA max.
Standby mode	25.0nA max. (Overdischarge latch function enable.) 0.6uA max. (Overdischarge latch function disable.)

Package type

•WLCSP-6D/6E/6F	1.26 × 0.83 × 0.36 [mm]
-----------------	-------------------------





Features

*Parameter setting table

Parameter	Symbol	Method	Setting range	Note
Overcharge hysteresis	Vdet1	Fuse	4.200V ~ 4.800V, 1mVstep	Accuracy: +/-10mV at Ta=25°C
Overcharge release	OCVREL	Fuse	A) No Hysteresis Latch B) Auto release	A) Vdet1=Vrel1 B) Vdet1>Vrel1 Hysteresis is canceled, when charger is removed.
Overdischarge detection voltage	Vdet2	Fuse	2.000V ~ 3.400V, 5mVstep	Accuracy: +/-35mV at Ta=25°C
Overdischarge release	ODVREL	Fuse	A) No Hysteresis Latch B) Auto release	A) Vdet2=Vrel2 B) Vdet2<Vrel2 Hysteresis is canceled, when charger is connected.
Discharging overcurrent detection voltage	Vdet3	Fuse	10.0mV ~ 150.0mV, 1mVstep	Accuracy: +/-2.0mV at Ta=25°C
Discharging overcurrent release	DOCREL	Fuse	A) Connected charger B) Auto release	A) V- is pull up to VDD by Rpu B) V- is pull down to VSS by Rpd
Charging overcurrent detection voltage	Vdet4	Fuse	-10.0mV ~ -70.0mV, 1mVstep	Accuracy: +/-3mV at Ta=25°C
		Metal Fuse	-70.0mV ~ -150mV, 1mVstep	
Charging overcurrent release	COCREL	Fuse	Remove charger and Connected load	
Short detection voltage	Vshort	Fuse	40mV ~ 300mV, 5mVstep	Accuracy: +/-3mV at Ta=25°C
Overcharge detection delay time	tVdet1	-	1024ms Fix.	Accuracy: +/-20% at Ta=25°C
Overcharge release delay time	tVrel1	-	16ms Fix.	
Overdischarge detection delay time	tVdet2	Fuse	20ms, 64ms, 96ms, 128ms	Accuracy: +/-20% at Ta=25°C
Overdischarge release delay time	tVrel2	Fuse	1ms, 4ms	
Discharging overcurrent detection delay time	tVdet3	Fuse	6ms, 12ms, 32ms, 512ms	Accuracy: +/-20% at Ta=25°C
Charging overcurrent detection delay time	tVdet4	Fuse	8ms, 16ms, 32ms	Accuracy: +/-20% at Ta=25°C
Charging / Discharge overcurrent release delay time	tVrel3 tVrel4	-	4ms Fix.	
Short detection delay time	tVshort	Fuse	250 ~ 500us, 10us step	Accuracy: +/-30% at Ta=25°C
0V battery charging function	0VCHG	Fuse	permission Inhibition: 1.25 ~ 2.00V, 0.05Vstep	Accuracy: +/-0.05V at Ta=0~50°C

fig1. Overcharge hysteresis

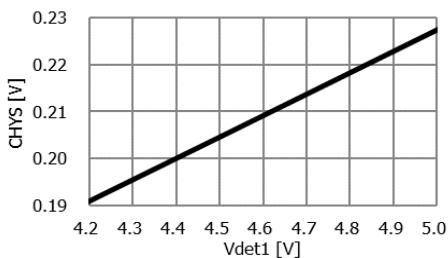
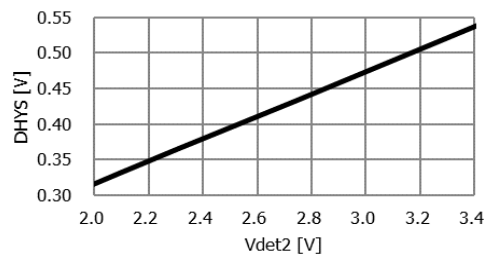
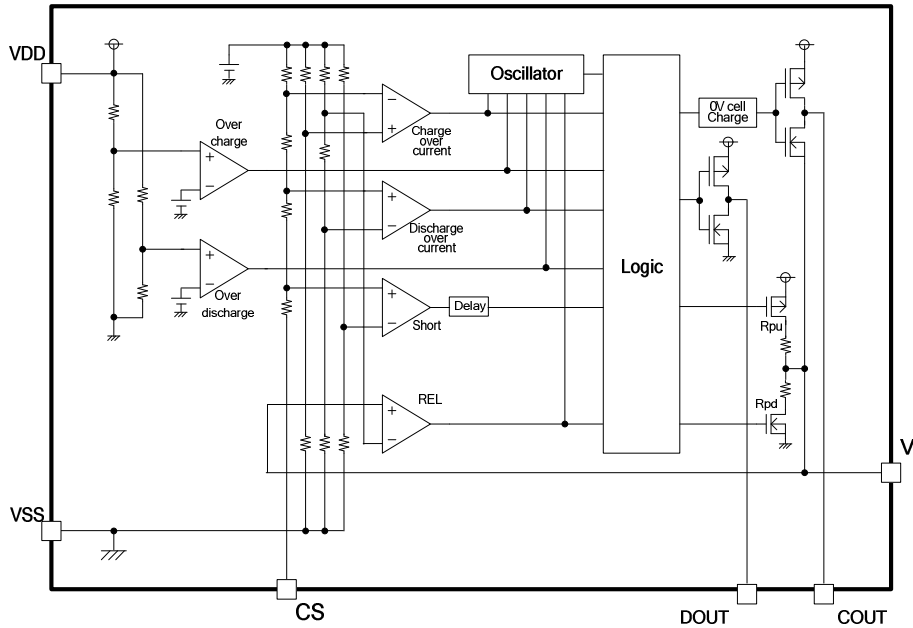

fig2. Overdischarge hysteresis





Block Diagram



Package and pin configuration

WLCSP-6D / WLCSP-6E / WLCSP-6F	Pin No.	Symbol	Function
(Top View) 	A1	V-	Input terminal for charger negative voltage
	A2	COUT	Control terminal for charge FET
	B1	VDD	Input terminal for positive power supply voltage
	B2	CS	Input terminal for overcurrent detection
	C1	VSS	Input terminal for negative power supply voltage
	C2	DOUT	Control terminal for discharge FET



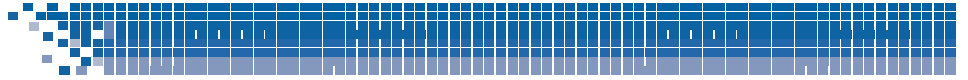

Package dimensions

Unit:mm

WLCSP-6D / WLCSP-6E / WLCSP-6F

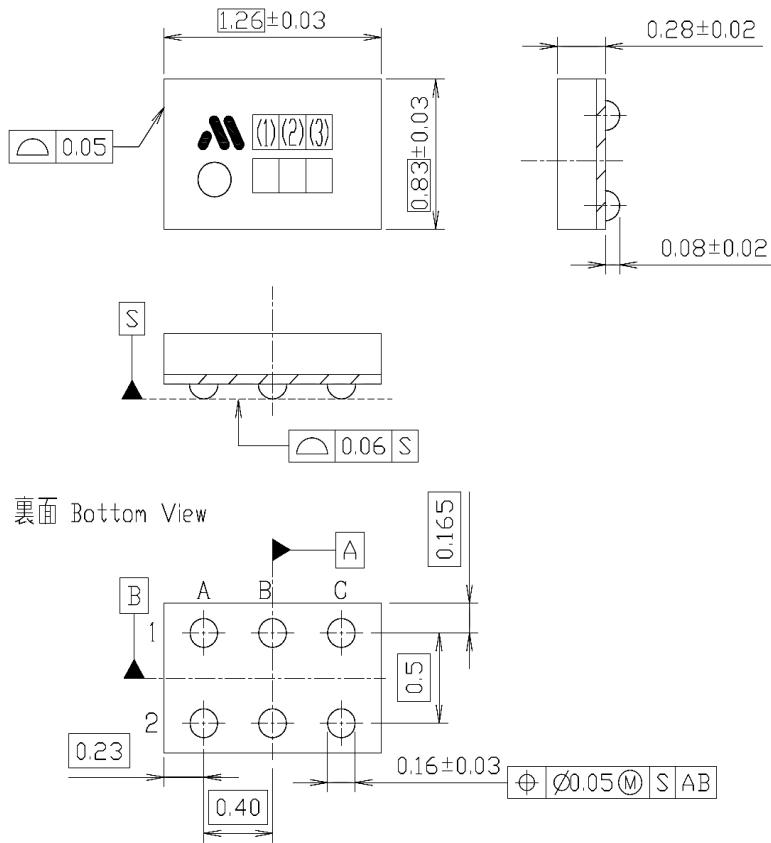

Marking Contents

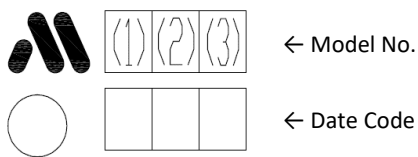

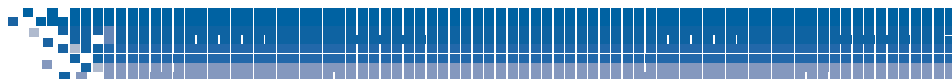

Absolute Maximum Ratings

Parameter	Symbol	Rating	Unit
Supply voltage	VDD	-0.3 to 12	V
V- terminal voltage	V-	VDD-28 to VDD+0.3	V
COOUT terminal voltage	VCOOUT	VDD-28 to VDD+0.3	V
DOOUT terminal voltage	VDOOUT	VSS-0.3 to VDD+0.3	V
CS terminal voltage	VCS	VDD-28 to VDD+0.3	V
Storage temperature	Tstg	-55 to +125	degC

Recommended Operating Conditions

Parameter	Symbol	Rating	Unit
Operating ambient temperature	Topr	-40 to +85	degC
Operating voltage	Vop	1.5 to 5.5	V

Electrical characteristics

(Unless otherwise specified, Ta=25 degC)

Parameter	Symbol	Condition	Min.	Typ.	Max.	Unit
Discharge overcurrent release resistance	Rshort	VDD=3.6V, VCS=0V, V-=2V Discharge overcurrent mode	10.0	20.0	40.0	kohm
V- terminal pull-up resistances	Rpu	VDD=1.8V, VCS=V-=0V	150	300	600	kohm
COOUT output resistance L	RcoL	Ta=-40 - 85°C VDD=4.6V, COOUT=0.1V	-	5.0	20.0	kohm
COOUT output resistance H	RcoH	Ta=-40 - 85°C VDD=4.0V, COOUT=3.9V	-	5.0	20.0	kohm
DOOUT output resistance L	RdoL	Ta=-40 - 85°C VDD=1.8V, DOOUT=0.1V	-	5.0	20.0	kohm
DOOUT output resistance H	RdoH	Ta=-40 - 85°C VDD=4.0V, DOOUT=3.9V	-	5.0	20.0	kohm
Current consumption	Idd	Ta=-40 - 85°C VDD=4.0V, VCS=V-=0V	-	3.0	6.0	uA
Current consumption at stand-by	Is	Ta=-40 - 85°C *1 VDD=1.5V, VCS=V-=VDD or Open	-	-	25.0	nA
		Ta=-40 - 85°C *2 VDD=1.5V, VCS=V-=VDD or Open	-	0.3	0.6	uA

*1 Overdischarge latch function enable.

*2 Overdischarge latch function disable.





Electrical characteristics

(Unless otherwise specified, Ta=25 degC)

Parameter	Symbol	Note	Min.	Typ.	Max.	Unit
Overcharge detection voltage	Vdet1	Ta=25°C	-0.010	Vdet1	+0.010	V
		Ta=-20 - 60°C	-0.020		+0.010	
Overcharge release voltage	Vrel1	*3	-0.030	Vrel1	+0.010	V
		*4	-0.030		+0.030	
Overdischarge detection voltage	Vdet2		-0.035	Vdet2	+0.035	V
Overdischarge release voltage	Vrel2	*1	-0.035	Vrel2	+0.035	V
		*2	-0.065		+0.065	
Discharging overcurrent detection voltage	Vdet3		-2.0	Vdet3	+2.0	mV
Charging overcurrent detection voltage	Vdet4		-3.0	Vdet4	+3.0	mV
Short detection voltage 1	Vshort1		-3.0	Vshort1	+3.0	mV
Short detection voltage 2	Vshort2		VDD-1.2	VDD-0.9	VDD-0.6	V
Overvoltage charger detection voltage	VhiChg		5.5	7.5	9.5	V
0V battery charge permission charger voltage	Vst		-	-	1.2	V
0V battery charge inhibition battery voltage	Vst		-0.05	Vst	+0.05	V
Overcurrent release threshold voltage	VrelC		-0.15	VrelC	+0.15	V
Overcharge detection delay time	tVdet1		-20%	tVdet1	+20%	s
Overdischarge detection delay time	tVdet2		-20%	tVdet2	+20%	ms
Discharging overcurrent detection delay time	tVdet3		-20%	tVdet3	+20%	ms
Charging overcurrent detection delay time	tVdet4		-20%	tVdet4	+20%	ms
Short detection delay time	tshort		-30%	tshort	+30%	us

*1 Overdischarge latch function enable.

*2 Overdischarge latch function disable.

*3 Overcharge latch function enable.

*4 Overcharge latch function disable.





Typical application circuit

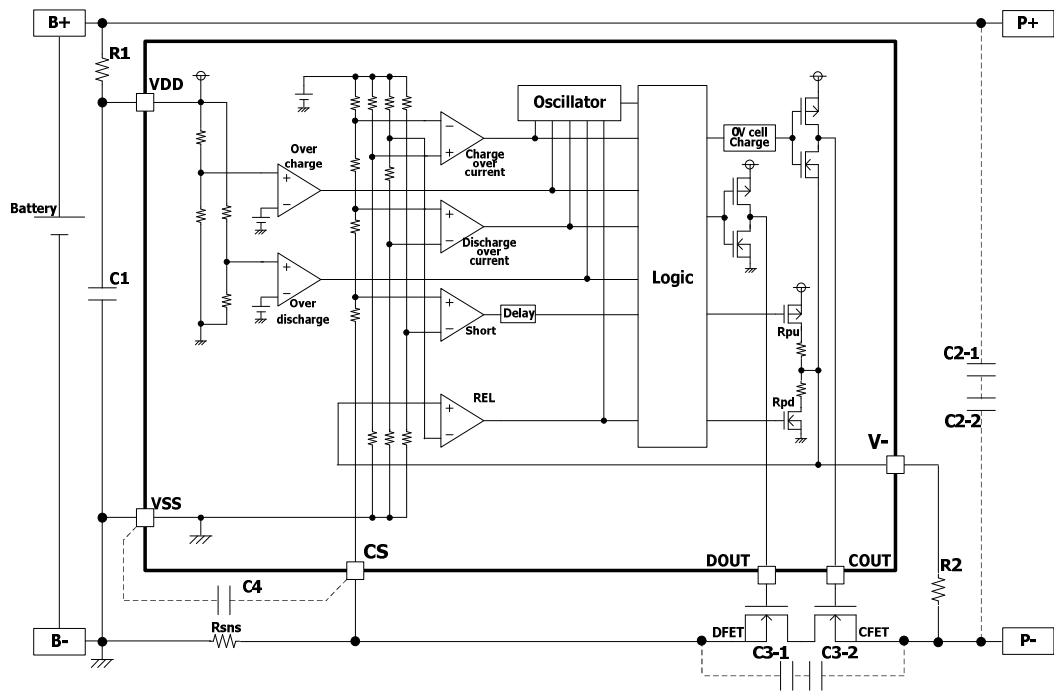

Unit:ohm ,F

Symbol	Part	Min.	Typ.	Max.	Purpose
R1	Resistor	-	100	1k	For voltage fluctuation, For ESD
R2	Resistor	-	1k	10k	Current limit for charger reverse connection
R3	Resistor	-	1k	10k	Current limit for charger reverse connection
Rns	Resistor	-	-	-	Current sense resistor
C1	Capacitor	0.01u	0.1u	1.0u	For voltage fluctuation
C2	Capacitor	-	0.1u	-	For exogenous noise
C3	Capacitor	-	0.1u	-	For exogenous noise
C4	Capacitor	-	0.1u	-	For exogenous noise
DFET	Nch MOS FET	-	-	-	Charge and discharge control
CFET					

*The above application circuit and constant value do not guarantee proper operation.

*Please evaluate thoroughly by actual application to set up constants.

